

SOAP BOX DERBY®



MASTERS CAR PLANS

Updated February 2022

Table Of Contents

Introduction		Page 3
General Assembly Guidelines		Page 4
Help, Guidance & Support		Page 4
Supplies & Tools		Page 5
Notes to the Builder		Page 6
Body Dimensions & Length		Page 6
Driving Position		Page 6
Floorboard		Page 7
Shell		Page 8
Pre-Build		Page 9
Step One	Shell Construction - Prep for Hatch	Page 10
Step One	Shell Construction - Hatch Attachment.	Page 12
Step One	Shell Construction - Attach Hinge to Hatch	Page 15
Step One	Shell Construction - Attach Hinge to Shell	Page 16
Step One	Shell Construction - Headrest.	Page 17
Step One	Shell Construction - Helmet Bracket	Page 19
Step One	Shell Construction - Hatch Foam	Page 21
Step One	Shell Construction - Face Protection/Headrest	Page 22
Step Two	Front Running Gear	Page 25
Step Three	Rear Running Gear	Page 28
Step Four	Triangulation	Page 32
Step Five	Steering Kit Base.	Page 33
Step Six	Brake Pad Installation	Page 35
Step Seven	Brake Plunger	Page 36
Step Eight	Steering Assembly	Page 37
Step Nine	Brake Assembly	Page 42
Step Ten	Front Axle Alignment	Page 46
Step Eleven	Airfoils	Page 47
Step Twelve	Axle/Steering Cable Cutouts	Page 48
Step Thirteen	Shell Attachment	Page 52
Step Fourteen	Weights	Page 54
Step Fifteen	Lettering & Decorations	Page 55
Step Sixteen	Wheel Installation	Page 56
Step Seventeen	Assembly Checklist	Page 57



Introduction

Welcome to Soap Box Derby® racing! The Soap Box Derby program is designed to be an enjoyable learning experience for both the adult and the child. The program provides an opportunity to develop mutual respect and trust while demonstrating the importance of individual pride and sportsmanship.

The Masters Car is designed to be always driven in a lay down position for builders of a specific age range (10-20). The combined weight of the assembled car and the driver shall not exceed 255 lbs. including the Z-Glas® wheels. A combined weight of less than 255 lbs. may be increased through the addition of owner provided weight.

The written rules, plans and regulations are designed for the participant to construct the car from a Masters Car kit purchased from the International Soap Box Derby, Inc. For rules and regulations, including eligibility and age range information, see the "Rule Book" available from the International Soap Box Derby, Inc. at soapboxderby.org. The established rules, plans and regulations shall be applicable to all races and events and shall be considered as to all issues involving the construction of a car. By participating in these events, all participants are deemed to have consented to the rules and authority of person who shall enforce the rules.

No expressed or implied warranties of any kind, including any warranty of safety, shall result from the publication or compliance with these rules, plans and regulations. In no event shall the International Soap Box Derby, Inc. be liable for any loss, indirect, special, or consequential damages even if the International Soap Box Derby, Inc. has notice of possibility of such damages. The International Soap Box Derby, Inc. makes no warranties, including any warranties of fitness for a particular purpose with respect to the publication or compliance with these rules, plans or regulations. In all situations, the rules and regulations promulgated by the International Soap Box Derby, Inc. shall govern and control over any conflicting provision in these plans.

Each participant understands and agrees that a prerequisite to competing in any championship race sanctioned by the International Soap Box Derby Inc. in Akron, Ohio, that the racer and his or her car shall undergo, and pass inspection conducted at Akron, Ohio by the International Soap Box Derby Inc. Each participant further understands and agrees that such inspection shall be conducted using the manner and methods deemed appropriate by the International Soap Box Derby Inc. in its sole discretion to determine compliance with the rules, plans, regulations, spirit of the rules and specifications applicable to that division and that the decisions of the International Soap Box Derby Inc. and its officials regarding qualifications and disqualification in compliance with the rules, spirit, plans, regulations, and specifications applicable to that division shall be final and binding upon all parties.

This guide contains proprietary information of the International Soap Box Derby (ISBD). It is intended solely for the information and use of parties building a Soap Box Derby® Masters Car. Such proprietary information may not be used, reproduced, or disclosed to any other parties for any other purpose without the expressed written permission of ISBD.

General Assembly Guidelines

A parent, guardian, teacher, coach, or mentor is expected to help in the construction of the car. The parent, guardian, teacher, coach, or mentor must not build the car for the child, but instead share this educational experience by being present and giving help only when and if necessary.

This plan booklet shall be followed when assembling your car. The hardware provided in the International Soap Box Derby, Inc. Masters Car kit must be used and assembled as shown in the latest rules, plans and specifications. No changes, modifications, or additions, other than the inclusion or omission of specified optional parts, shall be made to the car.

Replacement of all hardware, as well as optional parts, is available from the International Soap Box Derby, Inc. In general, replacement parts are sold in bags specified for each installation step of the car's construction and optional parts are available on a per item basis.

Altering, modifying, or tampering with the floorboard, shell, or any other hardware is prohibited and means for disqualification. Changes, alterations, modifications and/or replacements not authorized by the plans and/or rules should NOT be assumed to be legal under the "Spirit of the Rules."

Help, Guidance & Support

Questions or inquiries for clarification pertaining to the rules, plans and/or regulations shall be directed primarily to your Local Race Director and/or Regional Director. The International Soap Box Derby, Inc. also offers a web site at www.soapboxderby.org that provides additional assistance to the parent, guardian, teacher, coach, mentor and/or child. The website contains links to useful information such as the latest rules and plans, ordering kits or parts online, Local Race city organization contact information and frequently asked questions to name a few.

If further explanation is needed, questions should be directed to the International Soap Box Derby, Inc. All questions or inquiries for clarification must be emailed to raceprograms@soapboxderby.org.

Please note that a response to a specific participant's question may not apply to all other participants.



Supplies and Tools

The following items are needed in the basic assembly of the **Masters Car Running Gear**. The International Soap Box Derby, Inc. does not provide these tools as part of the kit. Sources for these tools include, but are not limited to, hardware and automotive supply stores.

1. 7/16" wrench
2. 7/16" socket and ratchet
3. ½" wrench
4. ½" open-ended wrench
5. Pencil
6. Power Drill
7. ¼" drill bit
8. 1⅝" spade drill bit or 1⅝" Forstner bit
9. Hammer
10. Pliers
11. 5/64" Allen Wrench
12. Wire Cutters
13. ½" drill bit or ½" Forstner bit
14. Wide flat blade screwdriver
15. "C" Clamps

The following items are needed in the basic assembly of the **Masters Car Shell**. The International Soap Box Derby, Inc. does not provide these tools as part of the kit. Sources for these tools include, but are not limited to, hardware and auto-motive supply stores.

1. Epoxy Glue - It is suggested that the builder use a two-part epoxy to join the two halves (PC-7, PC-11, or similar epoxy).
2. Two "C" clamps
3. Sander – Electric or sandpaper can be used
4. Drill
5. Pencil
6. Saw of your choice – used to cut airfoils
7. Small flathead screwdriver
8. Power Drill
9. 9/64" drill bit (hatch hinge)
10. ¼" drill bit
11. ½" wrench or pliers
12. Hacksaw with blade designed for cutting tile or jigsaw – used for axle cutouts in shell
13. Square
14. Wire Snips
15. Tool to remove excess lip on shell
16. Orbital Sander, Rasp, Jigsaw (all optional)
17. Contact cement – for hatch foam
18. Bondo (with or without fiberglass grindings)

The following items are OPTIONAL to aid in the assembly and basic finish of the Masters Car. The International SoapBox Derby, Inc. does not provide these tools or supplies as part of the kit. Sources for these tools include, but are not limited to, hardware and automotive supply stores.

1. Metal Cleaning Materials
 - a. Steel wool
 - b. Non-metallic abrasive pad
2. Finishing
 - a. Automotive wax
 - b. Paint (see tech tips on optional finishes)
3. Support Boards
(2) 2 x 4 x 18"
4. Feeler Gauges
5. Tung Oil (optional)
6. Framing Square
7. Router
8. Wood Chisel
9. Electrical Tape
10. Measuring Tape (10' minimum length)



Notes to the Builder

It is the intent of the International Soap Box Derby to establish standardized rules for this division. Do not read between the lines, that is where all the problems have appeared. If you cannot find the answer to your question in the following plans, send an e-mail to raceprograms@soapboxderby.org and we will answer your question promptly. Keep the response e-mail for future clarifications during inspection of your car.

Clarifications to any existing rules and specifications will be published on www.soapboxderby.org and in the Soap Box Derby communications as they happen.

Body Dimensions and Length

The minimum body circumference dimension of $36\frac{1}{2}$ " must be maintained. This measurement is taken directly in front of the hatch opening on the front portion of the shell from the bottom of the shell or floorboard on the left side over the top to the bottom of the shell or floorboard on the right side. Shell cannot be dropped below the floorboard. (See Figure #1 below)

The Masters Car floorboard original shape must be maintained without alterations. Exception: Cupping out the top of the floorboard for the driver's seat and or feet and the side notches may need lengthening to allow a proper fit of the shell to the floorboard.

The height of the nose shall be $8\frac{1}{2}$ " high at $4\frac{1}{2}$ " back from the front of the car - measurement is taken on the outside of the car (See Figure Below). This verifies an unaltered shell. Notch your nose gauge for the screw in the nose of the shell. Do not include the screw and washer as part of the nose height measurement.

Length: Wheelbase must be a minimum 65" from king pin to king pin & spindle to spindle.

Driving Position

The car body and floorboard must be built so that the driver has quick and easy operation of the steering wheel and brake and a clear view to the front. The driver's eyes must be on a level above the top of the cockpit hatch at all times. The driver's hips must be parallel to the ground and their feet must be the forward most part of the body, when in a lay back position. The driver must steer with both hands on the steering wheel.

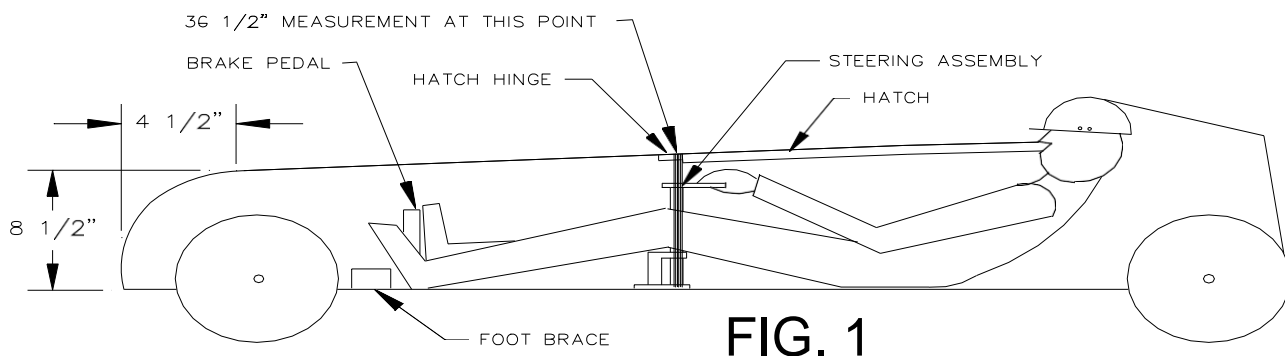

Floorboard

- The floorboard provided with the kit will have the final shape, kingpin holes, steering pulley holes, and mountingplate holes drilled in the proper locations (See Figure #1 below). These holes cannot be altered.
- The top of the floorboard has the logo. The bottom of the floorboard has a recess at the kingpins for the ¼" washer.
- The floorboard must be used without alterations. (Except for seat and feet area.)
- The top of the floorboard may be sanded or cupped out (maximum ¾") for driver's seat and/or feet area.
- You cannot add to nor groove out the bottom of the floorboard to incorporate wood, steel, or other materials into the floorboard.
- No continuous plate is permitted in the car, steel or any other material.
- A nailer strip is NOT permitted.
- Rounding of the floorboard is NOT permitted.
- Floorboards may be coated with tung oil or other commercially available products. Board may be coated on top, bottom & sides. It may also be waxed. Do not remove any of the edge marks from the side of the board.
- Clear tape is only permitted to cover unused holes on the bottom of the floorboard (no fillers in holes). The exception to this is the recessed area for the brake pad on the bottom side of the floorboard. If the recessed area needs to be moved the hole can be filled with a block of wood using ONLY two drywall screws to secure it.
- **No thread locking liquids or tapes may be used on bolts.**

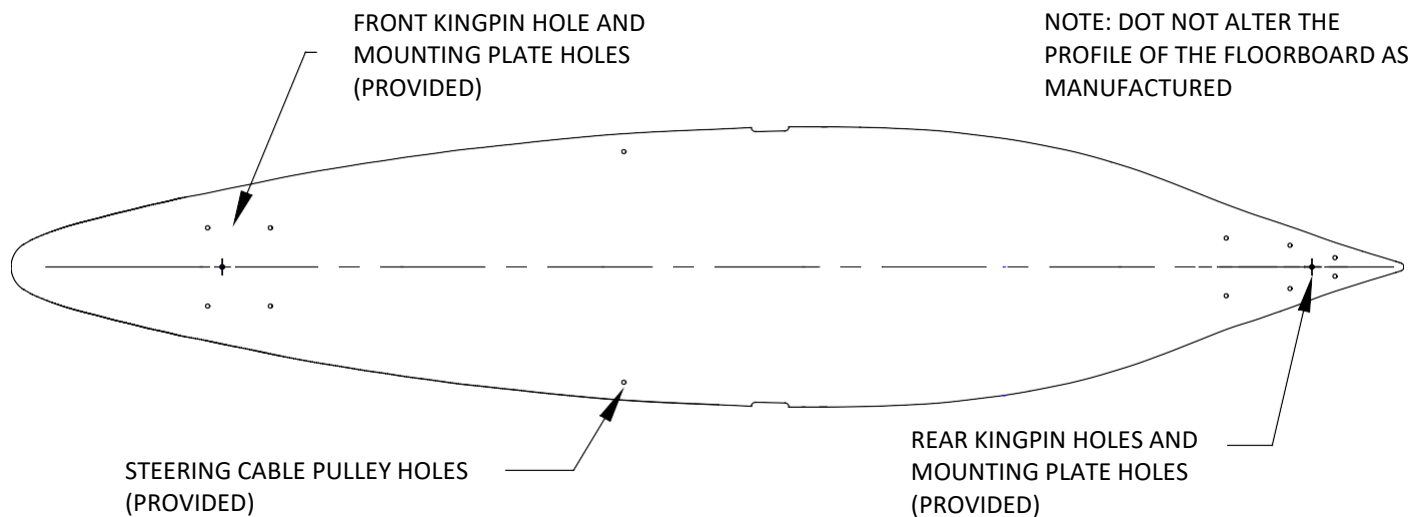

MASTERS FLOORBOARD FIG.1



Shell

- Only an approved fiberglass Masters Shell from the International Soap Box Derby is allowed.
- No cutting of the shell is allowed other than the axle openings, cable openings, optional inspection access hole, hatch, and head rest areas.
- **No shaping of the shell is allowed.**
- Fiberglass, carbon fiber, or other similar materials are NOT permitted to be used on the inside or outside of the car. Fiberglass may be used for Racing Commission authorized repairs.
- "Bondo" automotive type body filler can only be used on the outside of the car at the following areas: body side seam, hatch and headrest and optional access hole. It cannot be used to cover the hatch hinge or added to make the required nose height, the 36½" midpoint measurement or to sharpen the tail. Automotive body filler with ground up fiber glass is permitted.
- An inspection/repair access hole is optional but recommended. If an access hole is provided, it must be located at the top center of the car and must be large enough to put your arm in to make any repairs to brake or axle mounting components (3" x 3" min. opening) (See Figure #1)
- Inspect all fiberglass sections of your racer for excessive flashing, you may sand flashing on the inside of the shell and wax the inside of the shell. Rough up the white gel coat finish where the body parts overlap with rough sandpaper.

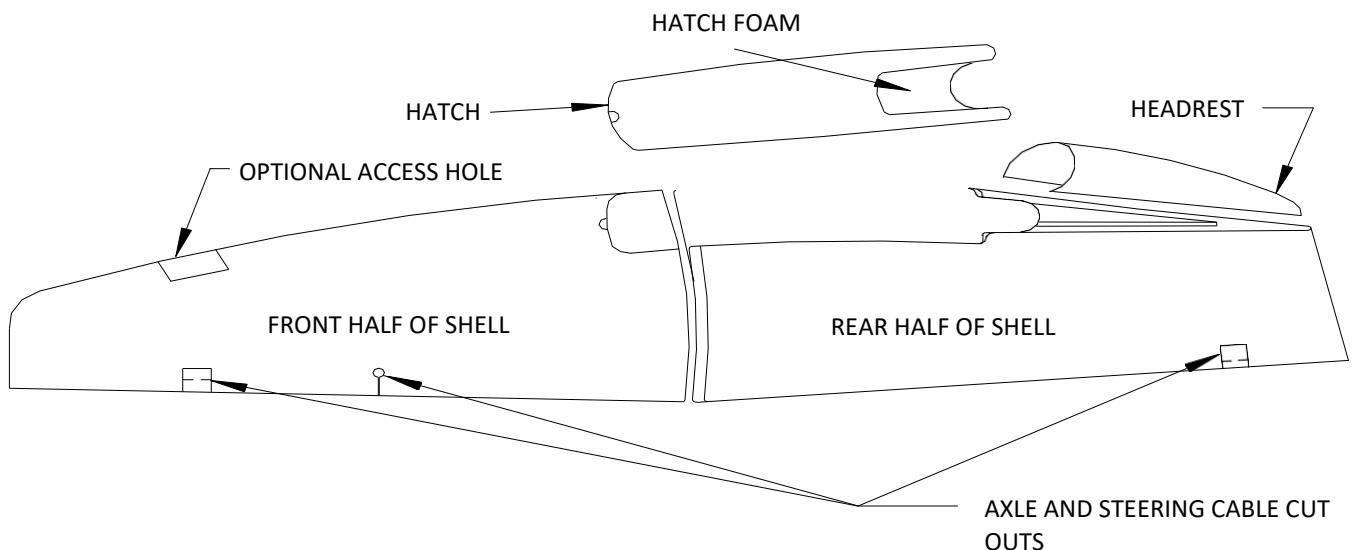

FIG.1



Pre-Build



Photo #1

Surface

Before you start the building process make sure your floorboard is sitting on a flat surface.

Tung Oil

Clear tung oil and wax are the only acceptable products that may be applied to the floorboard. Tung Oil such as Minwax and Formby's are available on the open market. The Tung Oil and wax may be used on all surfaces of the floorboard. Board may be coated on top, bottom & sides. Do not remove any of the edge marks from the side of the board. If you decide to use tung oil or wax it is recommended that you apply the product before you begin the building process.

Determine Center Point of Floorboard

Before you start the building process it is recommended that you determine the center point of your floorboard. To do this you'll need to find the center line from the front kingpin hole to the back kingpin hole (Photo #1). This will help you later when you determine your steering, braking and weight locations.

Please remember that the top of floorboard has the logo. The bottom of the floorboard has a recess at the kingpins for the $\frac{1}{4}$ " washer.

Get a Rough Idea of Where Your Driver Will Sit

Before you start the building process it is recommended that you determine where your driver will sit in the car. With a pencil mark the spots where you think you'll want the brake pedal and foot brace if you are using the traditional steering and braking system. If you are using the optional steering/hand-brake assembly, you can rough-in where you want that located along with the foot brace.

Shell

Please be aware of the temperature in the room when you are putting together your shell. The shell will expand and contract depending on temperature. This is important when you are aligning the hatch on the shell. Make sure the temperature is consistent when you complete Step 1.

Step One Shell Construction - Shell Prep for Hatch (Attach Front and Rear Shell Pieces)Shell

Prep for Hatch

- 1.1 Sand the inside lip of the front shell piece that will be attached to the rear shell piece. See Photo #1.1.
- 1.2 Sand the outside lip of the rear shell piece that will be attached to the front shell piece. See Photo #1.2.
- 1.3 Set the front and rear shell pieces on the floorboard. Make sure the front piece is tight against the front part of the floorboard. Make sure the back piece is tight against the rear part of the floorboard.
See Photo #1.3A & 1.3B. Make sure the entire shell is flush with the bottom of the floorboard.
- 1.4 Glue the front and rear pieces. It is suggested that the builder use a two-part epoxy to join the two halves. (PC-7, PC-11, or similar epoxy). Apply the glue on the front and rear shell pieces (See Photo #1.4A) and then clamp together. See Photo #1.4B.
- 1.5 Builder may screw, bolt, or rivet the sides together. In this example we are adding four drywall screws to each side to help pull both pieces of the shell together as the glue dries.
See Photos #1.5A & 1.5B.
After the epoxy has dried, it is suggested that the fasteners be removed. If the fasteners are not removed the excess on the inside of car must be trimmed and the fasteners on the outside of car must be sanded smooth.

Photo #1.1



Photo #1.2



Photo #1.3A



Photo #1.3B



Step One

Shell Construction - Shell Prep for Hatch continued



Photo #1.4A



Photo #1.4B

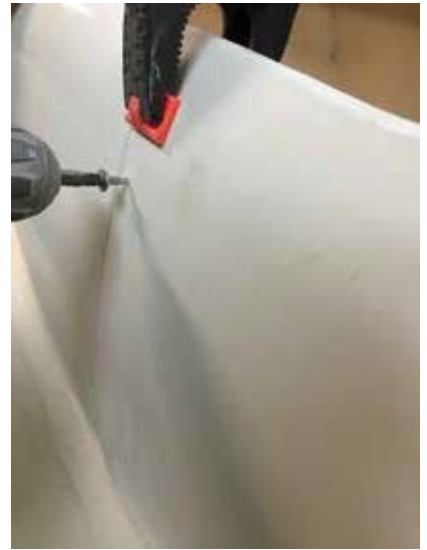

Photo #1.5A



Photo #1.5B



Step One

Shell Construction – Hatch

Hatch Attachment

- The minimum opening in the car must be 12" wide and 21½" long all the way to the floorboard.
- No side reinforcement of the cockpit opening is permitted.
- You must use the Derby supplied single pin hinge for the cockpit hatch. The hatch and body may be reinforced with a block of wood, max size 2" x 3" x ¾" (MAX), where the hinge bolts are attached to the hatch or body. **The hinge may not be painted.**
- Velcro or magnets (not included in kit) should be used to hold down the hatch. No sharp objects will be allowed. All hinge bolts must be trimmed and filed smooth on the inside of the car for safety.
- You may use bolts & nuts of your choice for the hinge or Derby issued bolts & nuts.
- The area in front of the helmet must be padded with Derby supplied dense, white, sandable foam in the kit to ease installation. Do not put anything but foam in this area. Glue two pieces of foam together if you need longer foam. No body filler can be used.
- Derby issued foam must be used.
- You must be able to open and shut the hatch with the helmet in driving position.
- No painting over foam will be permitted. It may be dyed or colored with markers.
- There must be a minimum of 6" of Derby white foam installed in the hatch cutout area, in front of the drivers face.
- If a sight groove in the foam is used, it must be a min. of 5" wide by ¼" deep.
- A 2" x 2" clip will be allowed on both inside edges of the hatch opening to keep the body from spreading. This will be the only object allowed to intrude in the 12" wide cockpit opening area.

1.6 Place hatch on hatch opening. Align hatch so inside of hatch opening is aligned with inside of rear shell. See Photo #1.6A. Also make sure the hatch hinge area is aligned properly. See Photo #1.6B.

1.7 For the hatch to fit snug on the shell, trimming of shell is necessary. To do this you first must use a pencil and trace the outline of the hatch on the shell. See Photos #1.7A-1.7G.

1.8 Now is the time to trim the excess shell lip material. It is suggested that you use an orbital sander with coarse sandpaper. Other methods such as a jigsaw, rasp, etc. can be used. The use of a dust mask and eye protection is necessary for this step. You'll want to remove all the area on the inside of the shell lip up to the pencil line. **MAKE SURE YOU DO NOT REMOVE TOO MUCH OF THE SHELL LIP.** When sanding/filing/ etc. make sure you sand/file/etc. vertically from the inside of the shell. See Photos #1.8A & 1.8B. Finish sanding is needed to remove lip in corners. See Photo #1.8C. When finished removing the excess lip of the shell here is what it should look like: Before - Photos #1.8D-1.8F and After - Photos #1.8G-#1.8I.

Photo #1.6A



Photo #1.6B



Step One

Shell Construction - Hatch Attachment continued



Photo #1.7A



Photo #1.7B



Photo #1.7C



Photo #1.7D



Photo #1.7E



Photo #1.7F



Photo #1.7G



Step One

Shell Construction - Hatch Attachment continued



Photo #1.8A



Photo #1.8B



Photo #1.8C



Photo #1.8D



Photo #1.8E



Photo #1.8F



Photo #1.8G



Photo #1.8H



Photo #1.8I



Step One

Shell Construction - Attach Hinge to Hatch

Attach Hinge to Hatch

- Builder may use a 2" x 3" x 3/4" wood backer plate for additional support for the hinge inside of car.
- Attach hinge to the hatch using the provided hardware.
- **The hinge CANNOT be painted.**
- No material, including Bondo can be used to cover the hatch hinge

Note: The short side of the hinge is attached to the hatch. The larger side is attached to the shell.

- 1.9 Align the smaller side of the hinge to the hatch. Using a pencil mark the center hole. See Photo #1.9.
- 1.10 Using a 9/64" drill bit to drill out the hole. See Photo #1.10.
- 1.11 Place one screw through the top of the hinge through the hatch. Place nut and tighten. See Photo#1.11 from underneath.
- 1.12 Set the hatch on the shell and adjust to make sure the hinge is flush with the front shell and the hatch fits snug with the rear shell opening.
- 1.13 Drill the other two holes through the hinge and hatch. See Photo #1.13.
- 1.14 Remove the hatch and add the other two screws along with the nuts. See Photo #1.14 from underneath.



Photo #1.9



Photo #1.10



Photo #1.11



Photo #1.13



Photo #1.14

Step One

Shell Construction - Attach Hinge to Shell

Attach Hinge to Shell

- 1.15 Set the hatch back on the shell and drill the three holes through the hinge and front shell. See Photo#1.15.
- 1.16 Add the three remaining screws along with the nuts. See Photo #1.16A and 1.16B from underneath.
- 1.17 Hatch should fit snug on the shell. See Photo #1.17.
- 1.18 For safety reasons the excess screw length must be cut off using wire snips and sanded smooth, even if you are using a wood backer. See Photos #1.18A & 1.18B.

NOTE: Velcro or magnets (not included in kit) should hold down the hatch. No sharp objects will be allowed. Allhinge bolts must be trimmed and filed smooth on the inside of the car for safety.



Photo #1.15



Photo #1.16A



Photo #1.16B



Photo #1.17



Photo #1.18A



Photo #1.18B



Step One

Shell Construction - Headrest

Headrest

- The official helmet must not be recessed into the headrest so as to restrict the driver's vision. Driver must have the line of sight plus be able to view the racecourse at an angle over the front wheels.
- The line of sight is defined as no part of the car, this includes the hatch foam, may be higher than the first rivet on the helmet, when helmet is in race position. The first rivet must be always visible. See Figure #1.
- Builder may raise, lower, shorten or lengthen the headrest.
- Make sure there is a minimum 7" wide opening from the cockpit hatch all the way back to the first rivet of the helmet (See Figure #2).
- With the helmet in position, it shall measure a minimum of 7¼" on the outside across the width at the center. This can be obtained by trimming the helmet opening in the rear of the shell when positioning the helmet. The trimming will allow the helmet to expand to the 7¼" measurement and give it a surface to rest on.
- The helmet shall fit into the headrest and stay in position without the use of tape during the race. The helmet must be strapped to the driver's head before entering the car.
- It is necessary to trim the headrest area of the shell for the helmet to fit.

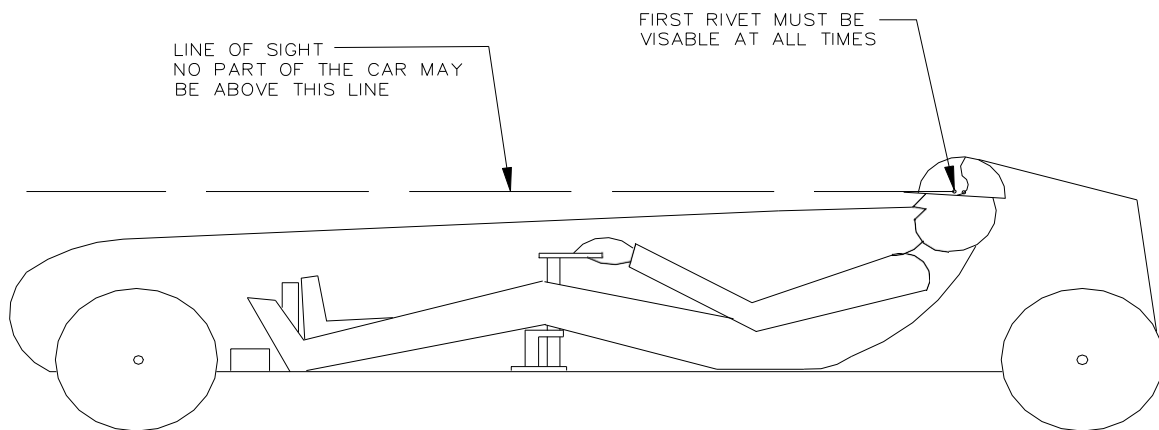

FIG. 1

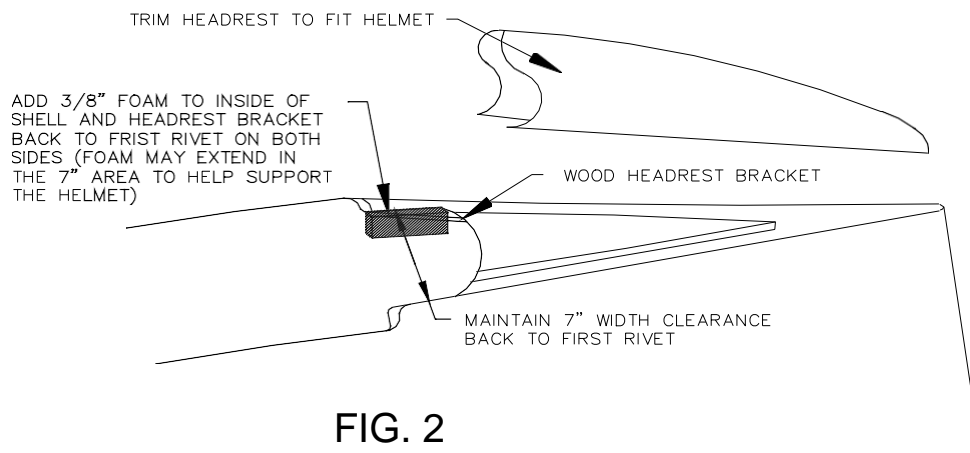

FIG. 2

Step One

Shell Construction - Headrest continued

- 1.19 Set the helmet on the rear of the shell to determine how much of the shell will need to be trimmed. Using a pencil trace the outline of the helmet. See Photos #1.19A-C.
- 1.20 Now is the time to trim the excess rear shell where the helmet will sit. It is suggested that you use an orbital sander with coarse sandpaper. Other methods such as a jigsaw, rasp, etc. can be used. The use of a dust mask and eye protection is necessary for this step. You'll want to remove all of the area on the inside of the shell lip up to the pencil line.
MAKE SURE YOU DO NOT REMOVE TOO MUCH OF THE SHELL. When sanding/filing/etc. make sure you sand/file/etc. vertically from the inside of the shell. See Photo #1.20.
- 1.21 When finished removing the excess rear shell the helmet should drop into the opening and fit snug. See Photos#1.21A-B.



Photo #1.19A



Photo #1.19B



Photo #1.19C



Photo #1.20



Photo #1.21A



Photo #1.21B



Step One

Shell Construction - Helmet Bracket

Helmet Bracket

- The helmet bracket can be altered to fit into the back half of the shell. It may need to be shortened in the front and rounded at the outside edges to make it fit.
- Body filler may be added to the helmet bracket (rear of the helmet) to help hold the helmet in place.
- Body filler may be used at the front ends of the helmet bracket to help attach it to the shell.

1.22 Clamp the wood horseshoe shaped piece to the rear shell helmet area. See Photo #1.22.

1.23 Using a 9/64" drill bit drill through the fiberglass shell (not into the wood) at the front of the headrest area of the shell on each side. See Photos #1.23A-B.



Photo #1.22



Photo #1.23A



Photo #1.23B

1.24 Drive a drywall screw through each hole location into the wood. DO NOT OVERTIGHTEN AS IT WILL CAUSE THE SHELL TO LOSE ITS SHAPE OR CRACK. See Photos #1.24A-B.

1.25 Remove clamps. See Photo #1.25.



Photo #1.24A



Photo #1.24B



Photo #1.25

Step One

Shell Construction - Helmet Bracket continued

- 1.26 Flip the shell over. Using a ¼" drill bit drill through the existing hole of the back area of the horseshoe and through the shell. See Photo #1.26.
- 1.27 Flip shell back over onto floorboard
- 1.28 Place 1¼" washer on Long Bolt
- 1.29 Insert Long Bolt through top of shell at rear hole location. See Photo #1.29.
- 1.30 Install 1¼" washer, two nuts and another washer on the bolt coming through the rear hole location. See Photo #1.30.
- 1.31 Tighten until top of bolt is flush with top of shell. See Photo #1.31.
- 1.32 Add a washer and then a nut to the bottom of the bolt and tighten to the bottom of the horseshoe. See Photo #1.32.

NOTE: Depending on how you want the helmet to sit in the headrest area you may need to loosen or tighten the two drywall screws in the front part of the headrest. This will allow for a different angle for the horseshoe. The back of the bracket is adjustable up and down with the ¼" bolt.



Photo #1.26



Photo #1.29



Photo #1.30

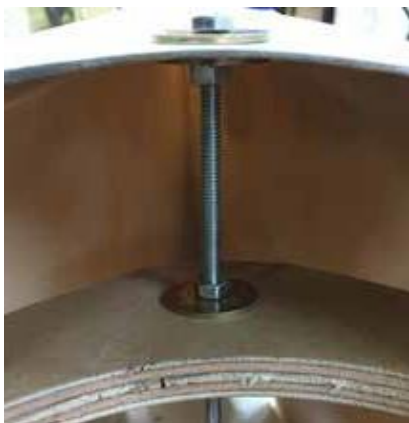

Photo #1.31



Photo #1.32



Step One

Shell Construction - Hatch Foam

Hatch Foam

- The area in front of the helmet must be padded with Derby supplied dense white sandable foam.
- Do not put anything but foam in this area.
- If you need a longer piece glue two pieces of foam together.
- No body filler is allowed on the inside edges of the hatch foam area.
- You must be able to open and shut the hatch with the helmet in driving position.
- No painting over foam is permitted. It may be dyed or colored with markers.
- There must be a minimum of 6" foam installed in the hatch cutout area, in front of the drivers face.
- If a sight groove in the foam is used, it must be a minimum of 5" wide by 1/4" deep.
- A 2" x 2" clip will be allowed (optional) on both inside edges of the hatch opening to keep the body from spreading. This will be the only object allowed to intrude in the 12" wide cockpit opening area. See Figure 1.

1.33 Place hatch foam in hatch area and set helmet in position. See Photo #1.33.

1.34 Using a pencil trace around helmet. See Photo #1.34.

1.35 Using a saw of your choice cut out the traced area on the foam. See Photo #1.35.

1.36 Apply contact cement to edge of foam and inner lip of hatch and set foam flush with the top of the hatch. See Photo #1.36.



Photo #1.33



Photo #1.34



Photo #1.35



Photo #1.36

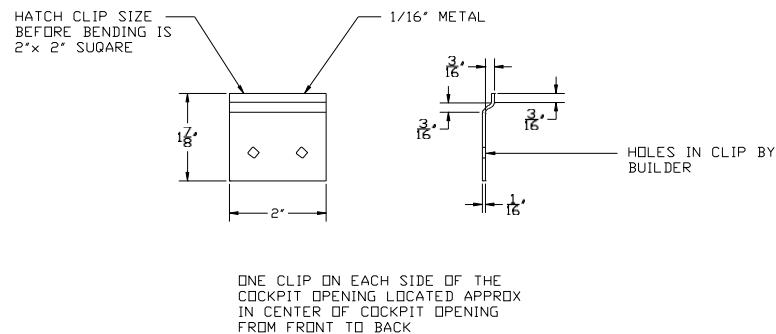

COCKPIT HATCH CLIP

FIG. 1



Step One

Shell Construction - Face Protection/Headrest

Face Protection

1.37 Builder must add a minimum 3/8" wide foam between the helmet cutout area and the shell. Foam may be larger. Hatch foam cut out for the helmet works well and can be shaped to support the helmet. Please see Photos #1.37A-B. Only adhesive should be used to attach the foam.

NOTE: There must be 7" clearance between the shell and wood helmet cutout bracket from the first rivet on the helmet all the way to the hatch. Nothing may extend into the 7" area except for foam. If there is not a 7" clearance you MUST sand the shell to maintain the clearance. See Photo #1.37C.



Photo #1.37A



Photo #1.37B



Photo #1.37C

Headrest

1.38 Position headrest so it sits flush with the back of the car. See Photo #1.38.

1.39 Add helmet and adjust horseshoe to determine site gap for driver. See Photo #1.39.

1.40 Measure distance from top of helmet to the inside of the shell at the top of the headrest. See Photo #1.40.



Photo #1.38



Photo #1.39

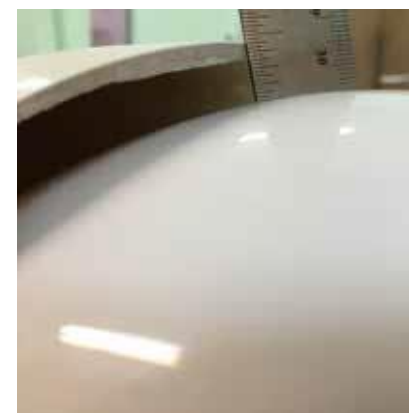

Photo #1.40



Step One

Shell Construction - Headrest continued

1.41 Remove headrest and transfer the distance from the top of the inside of the shell at the top of the headrest to the bottom of the headrest on both sides and trace a straight line with a pencil. See Photo #1.41.

1.42 Now trim the excess headrest TO PENCIL LINE. It is suggested that you use an orbital sander with coarse sandpaper. Other methods such as a jigsaw, rasp, etc. can be used. The use of a dust mask and eye protection is necessary for this step. MAKE SURE YOU DO NOT REMOVE TOO MUCH OF THE HEADREST. See Photos #1.42A-B.

1.43 Sand inside of headrest and outside edge of top of shell. See Photos #1.43A-B.



Photo #1.41



Photo #1.42A



Photo #1.42B

1.44 Glue the headrest to the top of the shell. Apply glue to inside of headrest and outside edge of top of shell. See Photos #1.44A-B. It is suggested that the builder use a two-part epoxy to join the two pieces. (PC-7, PC-11, or similar epoxy).

1.45 Drive four drywall screws (two on each side) into the headrest near the bottom to secure while glue dries.



Photo #1.43A



Photo #1.44A



Photo #1.43B



Photo #1.44B

Step One

Shell Construction - Headrest continued

Rear screw location MUST be a minimum 3½ inches away from the rear of car. See Photo #1.45A-C.

- 1.46 Once glue dries according to manufacturer you may remove the four screws. NOTE: Screws do not have to be removed. If the screws are not removed the excess on the inside of car must be trimmed. "Bondo" type filler can be applied to the seam of the headrest
- 1.47 Add helmet to headrest area to make sure clearance is correct. See Photo #1.47A. NOTE: "Bondo" type filler may be used in the headrest area to fill in gaps between helmet and headrest. See Photo #1.47B
- 1.48 The drywall screws from wood horseshoe. MUST BE TRIMMED. See Photo #1.48.



Photo #1.45A



Photo #1.45B



Photo #1.45C



Photo #1.47A



Photo #1.47B



Photo #1.48

The shell construction is complete. We suggest you set the shell on the floorboard (Do not have to attach) and have your driver get in the car in the racing position to confirm your steering and brake locations.

When everything checks out you can remove the shell and begin Step #2.



Step Two

Front Running Gear - Bushing, Mounting Plate, Axle Stop, Kingpin Stack

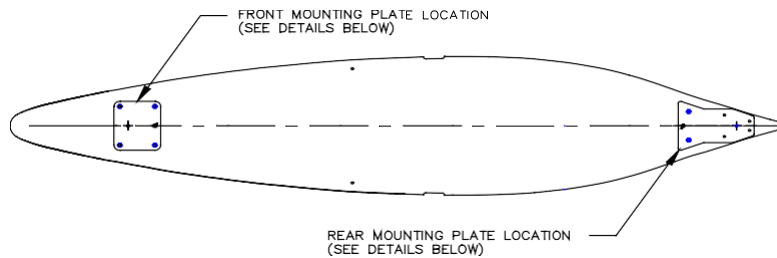

FRONT & REAR AXLE MOUNTING PLATE LOCATIONS

Bushing Installation Sub-Assembly

- Make sure the top of the floorboard (SBD shield side) is facing up.
- Kingpin bushing may be adhered to the floorboard using epoxy (provided by others). A limited amount of epoxy is acceptable.
- Floating of bushings in floorboard is NOT acceptable. There is no epoxy permitted on the kingpin. The kingpin must turn freely in the bushing.

2.1 Place $\frac{1}{4}$ " x $1\frac{1}{4}$ " fender washer on $\frac{1}{4}$ " x $3\frac{1}{4}$ " machine bolt. **Bolt is silver in color.**

2.2 Place bushing with flat end against fender washer on the $\frac{1}{4}$ " x $3\frac{1}{4}$ " machine bolt.

2.3 Insert assembly through the top of floorboard with beveled end of bushing against floorboard until bolt extends through opposite side of floorboard at kingpin location.

2.4 Place a $\frac{1}{4}$ " x $1\frac{1}{4}$ " fender washer on the machine bolt against the floorboard.

2.5 Install a $\frac{1}{4}$ " nut on $\frac{1}{4}$ " x $3\frac{1}{4}$ " machine bolt. See Photo #2.5

2.6 Tighten machine bolt assembly until **top bushing end** is flush with floorboard. Bottom of bushing should be flush with top of recessed area of floorboard. See Photo #2.6.

2.7 Remove $\frac{1}{4}$ " nut from $\frac{1}{4}$ " x $3\frac{1}{4}$ " machine bolt and $\frac{1}{4}$ " x $1\frac{1}{4}$ " fender washers.

2.8 Save $\frac{1}{4}$ " nut and $\frac{1}{4}$ " x $3\frac{1}{4}$ " machine bolt for rear bushing installation.

2.9 Epoxy may be used to secure the bushings in the floorboard. The expected way is to coat the inside of the hole in the floorboard with epoxy and then install the bushing before epoxy dries.

$\frac{1}{4}$ " x $1\frac{1}{4}$ " FENDER WASHER

$\frac{3}{8}$ " BUSHING

$\frac{1}{4}$ " x $1\frac{1}{4}$ " FENDER WASHER

$\frac{1}{4}$ " NUT

$\frac{1}{4}$ " x $3\frac{1}{4}$ " MACHINE BOLT

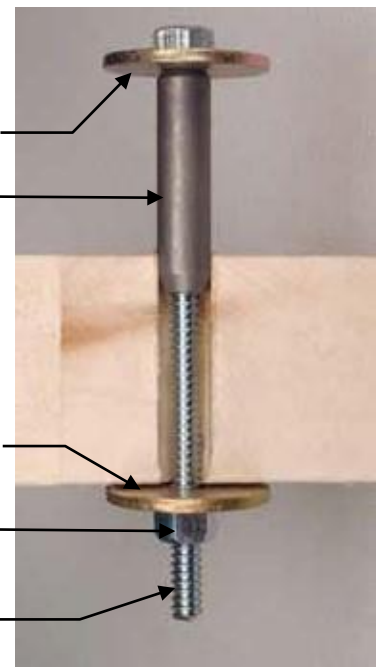

Photo #2.5

Step Two

Continued

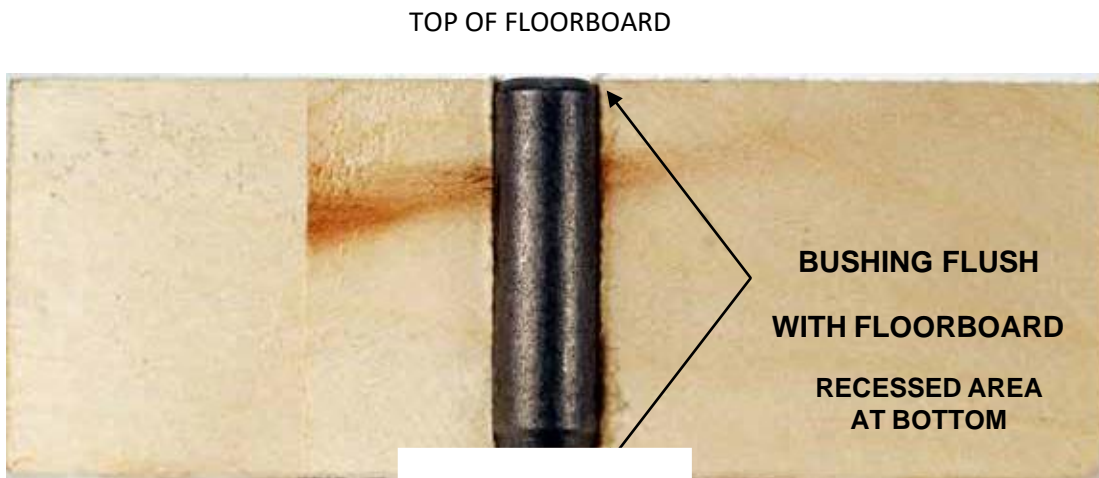

Photo #2.6

Front Plate Mounting

- Only International Soap Box Derby axle mounting plates, bushings, kingpins, washers, and hardware may be used
- Painting is not allowed on any ISBD issued part or the surface on the inside of the car. Exception is weights.
- One additional mounting plate may be added to the top of the first required mounting plate. No more than two plates (one required and one optional) will be permitted at each axle. Logo must be visible on top plate and bottomplate when top plate is removed.
- The front and rear bottom plates only may be epoxied to the top of the floorboard (The current rule is rescinded). Filet not allowed.
- No drilling of holes in mounting plate will be allowed.
- No painting, polishing, or surfacing of the plate is allowed.
- The footrest, axle stops, or brake pedal can be mounted on the front plate using only the 4 mounting bolts. No additional bolts can be used to secure additional parts to the front plate.

2.10 Align plate(s) with the four holes (logo on plate must be visible).

2.11 Put kingpin bolt (gold) through the kingpin hole (this helps with alignment).

2.12 From the bottom add an elevator bolt to each of the four holes in the floorboard. See Photo #2.12.

2.13 Add a ¼" lock washer to each bolt.

2.14 Add a ¼" -20 nut to each bolt. Tighten. See Photo #2.14. Note: Elevator bolts shall not be mechanically countersunk into the floorboard. Elevator bolts may only be pulled flush by normal tightening of the bolt. The floorboard may not be cut or drilled to accept the elevator bolt head.

2.15 Remove the kingpin bolt. See Photo #2.15.



Step Two

Continued



Photo #2.12



Photo #2.14



Photo #2.15



Photo #2.16a

Front Axle Stops

- Axle stops on the front two elevator bolts are required to limit the movement of the front axle. Movement is limited so that the front wheels cannot be moved more than 1 5/8" nor less than 3/8" off center (straight-ahead position) in either direction, forward or back. Measure at the end of the axle spindle.
- There are several ways to provide an axle stop. You can add three 1/4" SAE Washers - Yellow Grade 8 to each bolt (provided) along with the nuts or you can make your own. The height will be dependent on how high the washer stack will be under the axle. At least one 1/4"-20 nut must be on top of the stack. See Photo #2.16a as an example.



Photo #2.16b

Front Kingpin Stack

- Builder may use the washer stack of choice on the front axle.
 - Washer stack is limited by the length of the 3 1/2" kingpin bolt and the mandatory that is required between the head of the kingpin bolt and the bushing.
- #2.16b



Photo #2.17

2.16 As an example, add 1/4" SAE Washer – Yellow Grade 8 to the 1/4"-28 x 3 1/2" Bolt Yellow Grade 8. Insert Kingpin and washer through bushing from the bottom. See Photo #2.16b

2.17 It is recommended to add a washer to the kingpin. More washers may be added under the axle or on top of the axle (Note: Make sure you use enough washers, so you have enough threads on the Kingpin to add the 1/4" Nylon Insert Locknut YZ 8 nuts. The top of the kingpin bolt must be even or exceed the top nut.). NOTE: The top of the axle can be no higher than 3" from the bottom of the floorboard. See Photo #2.17

2.18 Install front axle. See Figure #2.18 to determine which is the front axle.

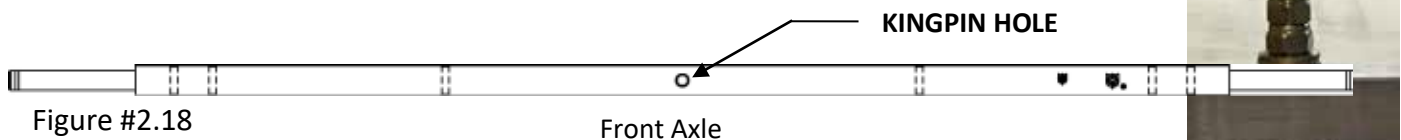

Figure #2.18

Front Axle

KINGPIN HOLE

NOTE: Prebowing is allowed. Pre-bowing is the arching of the axle to compensate for vertical loading. Under full load (car and driver) the axles are allowed to have a maximum 1/8" arch in the vertical dimension. Arch will not be allowed in the horizontal direction.

Axles must be pre-bowed by bending only. Other methods such as a peening, heating, etc., are not permitted.

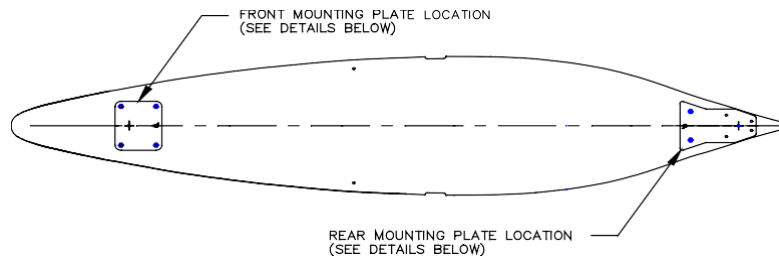

Photo #2.19

2.19 After you determine your washer stack you MUST add two 1/4" Nylon Insert Locknut YZ 8 nuts and tighten. In this photo (Photo #2.19) example there are four washers under the axle and four on top along with the nuts.

Step Three

Rear Running Gear - Bushing, Mounting Plate, Kingpin Stack, Tap Bolts



FRONT & REAR AXLE MOUNTING PLATE LOCATIONS

Bushing Installation Sub-Assembly

- Kingpin bushing may be adhered to the floorboard using epoxy (provided by others). A limited amount of epoxy is acceptable.
- Floating of bushings in floorboard is NOT acceptable. There is no epoxy permitted on the kingpin. The kingpin must turn freely in the bushing.

3.1 Please refer to steps 2.1 through 2.9 for rear bushing sub-assembly.

Rear Mounting Plate

NOTE: There are three options for the rear mounting plates. One comes with the kit. The other two options can be ordered separate from the kit (optional masters tube bag and optional masters rear bottom plate). The directions for the other two options are included with the kits.

- Only International Soap Box Derby axle mounting plates, angle iron bracket, alternate tubular brackets, bushings, kingpins, washers, and hardware may be used.
- Painting is not allowed on any ISBD issued part or the surface on the inside of the car. Exception is weights.
- One additional mounting plate may be added to the top of the first required mounting plate. No more than two plates (one required and one optional) will be permitted immediately under each axle. Logo must be visible on top plate and bottom plate when top plate is removed.
- The front and rear bottom plates only may be epoxied to the top of the floorboard. (The current rule rescinded.) Filet not allowed.
- No drilling of holes in mounting plate will be allowed.
- No painting, polishing, or surfacing of the plate is allowed.

Rear Mounting Plate Provided with Kit

3.2 Align plate with the six holes (logo on plate must be visible).

3.3 Put kingpin bolt (gold) through the kingpin hole (this helps with alignment)

3.4 From the bottom add the four 3" elevator bolts to the front and rear hole locations.

3.5 From the bottom add the two 2" elevator bolts to the center hole locations. See Photo #3.5



Photo #3.5



Step Three

Continued

- 3.6 Remove kingpin bolt. Add $\frac{1}{4}$ " -20 nut to the center bolt locations and draw elevator bolts tight against the floorboard. Remove nut.
- 3.7 Add $\frac{1}{4}$ " lock washer to the rear and center bolt locations.
- 3.8 Add $\frac{1}{4}$ " -20 nut to the rear and center bolt locations.
- 3.9 Tighten the four bolt locations. See Photo #3.9. Note: Elevator bolts shall not be mechanically countersunk into the floorboard. Elevator bolts may only be pulled flush by normal tightening of the bolt. The floorboard may not be cut or drilled to accept the elevator bolt head.
- 3.10. Add the angle iron to the front bolt locations. Note: Washers made be added underneath the angle iron to align the tap bolts (from future step 3.19).
- 3.11. Add $\frac{1}{4}$ " washer (SAE Washer Yellow Grade 8) to the front bolt locations.
- 3.12. Add $\frac{1}{4}$ " lock washer to the front bolt locations.
- 3.13. Add $\frac{1}{4}$ " -20 nut to the front bolt locations.
- 3.14. Tighten with finger. See Photo #3.14. Note: Elevator bolts shall not be mechanically countersunk into the floorboard. Elevator bolts may only be pulled flush by normal tightening of the bolt. The floorboard may not be cut or drilled to accept the elevator bolt head.



Photo #3.9



Photo #3.14

Rear Kingpin Stack

- Builder may use the washer stack of choice on the rear axle.
 - Washer stack is limited by the length of the $3\frac{1}{2}$ " kingpin bolt and a mandatory SAE Washer Yellow Grade 8 is required between the head of the kingpin bolt and the bushing. Please refer to Photo #2.16b.
- 3.15 Add $\frac{1}{4}$ " SAE Washer – Yellow Grade 8 to the $\frac{1}{4}$ " -28 x $3\frac{1}{2}$ " Bolt Yellow Grad 8. Insert Kingpin and washer through bushing from the bottom. Please refer to Photo #2.16b.
 - 3.16 It is recommended to add two washers to the kingpin. More washers may be added under the axle or on top of the axle (Note: Make sure you use enough washers, so you have enough threads on the Kingpin to add the $\frac{1}{4}$ " Nylon Insert Locknut YZ 8 nut. The top of the kingpin bolt must be even or exceed the top nut. The top of axle can be no higher than 3" from the bottom of the floorboard, see photo 2.17)

Step Three

Continued

3.17 Install rear axle. See Figure #3.17 to determine which is the rear axle.

NOTE: Prebowing is allowed. Pre-bowing is the arching of the axle to compensate for vertical loading. Under full load(car and driver) the axles are allowed to have a maximum 1/8" arch in the vertical dimension. Arch will not be allowed in the horizontal direction. Axles must be pre-bowed by bending only. Other methods such as a peening, heating, etc, are not permitted.

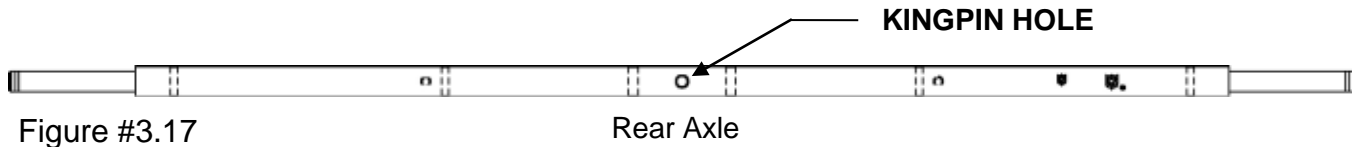

Photo #3.18A



Photo #3.18B

3.18 After you determine your washer stack add one 1/4" Nylon Insert Locknut YZ 8 nut and tighten. See Photo #3.18A. In this photo (Photo #3.18B) example there are four washers under the axle and four on top along with the nut.

Tap Bolt Installation

3.19 Install 1/4"-20 x 6" tap bolts through the rear of the axle.

3.20 Add one 1/4" lock washer to each bolt.

3.21 Add two 1/4"-20 nuts to each bolt.

3.22 Add SAE Washer Yellow Grade 8 to each bolt. See Photo #3.22.

3.23 Push tap bolts so they are flush with the axle. Snug the lock washer and nut to the axle on each bolt. Snug the nut and washer to the angle iron on each bolt. See Photo #3.23.

3.24 Center the tap bolts through the holes of the angle iron. Tighten the nuts on the elevator bolts going through the angle iron.

3.25 Add SAE Washer Yellow Grade 8 to each bolt coming through the angle iron. Add a 1/4" lock washer to each bolt and then a 1/4"-20 nut to each bolt. Finger tighten. See Photos #3.25 A & B.



Step Three

Continued



Photo #3.22

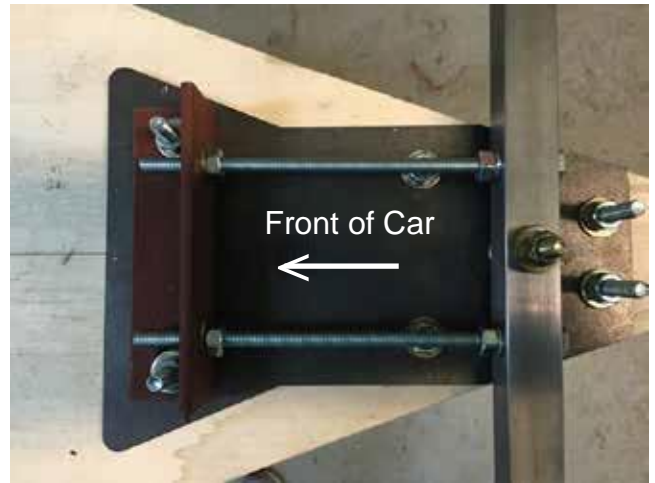

Photo #3.23



Photo #3.25A



Photo #3.25B

Step Four

Triangulation

Rear Axle Triangulation

- 4.1 The rear axle will need to be aligned to ensure that the car tracks properly in a straight line. This is known as Triangulation.
- 4.2 Obtain a metal tape measure (other triangulation tools can be used in this step) to create a "Triangulation Tool." Drill a $\frac{1}{4}$ " hole near the end of the tape measure See Photo #4.2
- 4.3 Take off first nut only on front axle kingpin. Slide the $\frac{1}{4}$ " hole end of the tape measure over the front axle kingpin. Slide out the tape measure to establish Dimension B (PT#2 and PT#3) close to the end of the tape. Mark locations PT#2 and PT#3.
- 4.4 Semi-tighten the rear running assembly and adjust the rear axle until both dimensions are exactly the same between PT#1 and PT#2, and PT#1 and PT#3. See Photo #4.4
- 4.5 If adjustments are needed loosen/tighten the nuts as shown in photo #4.5 (highlighted area) and make adjustments.
- 4.6 When both dimensions are equal, tighten the rear running gear assembly.
- 4.7 Check the measurements to ensure that it is equal.



Photo #4.2

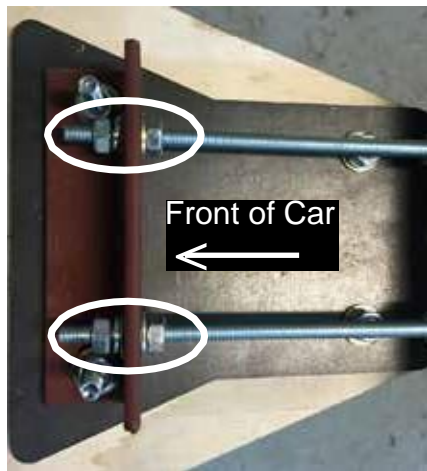

Photo #4.5

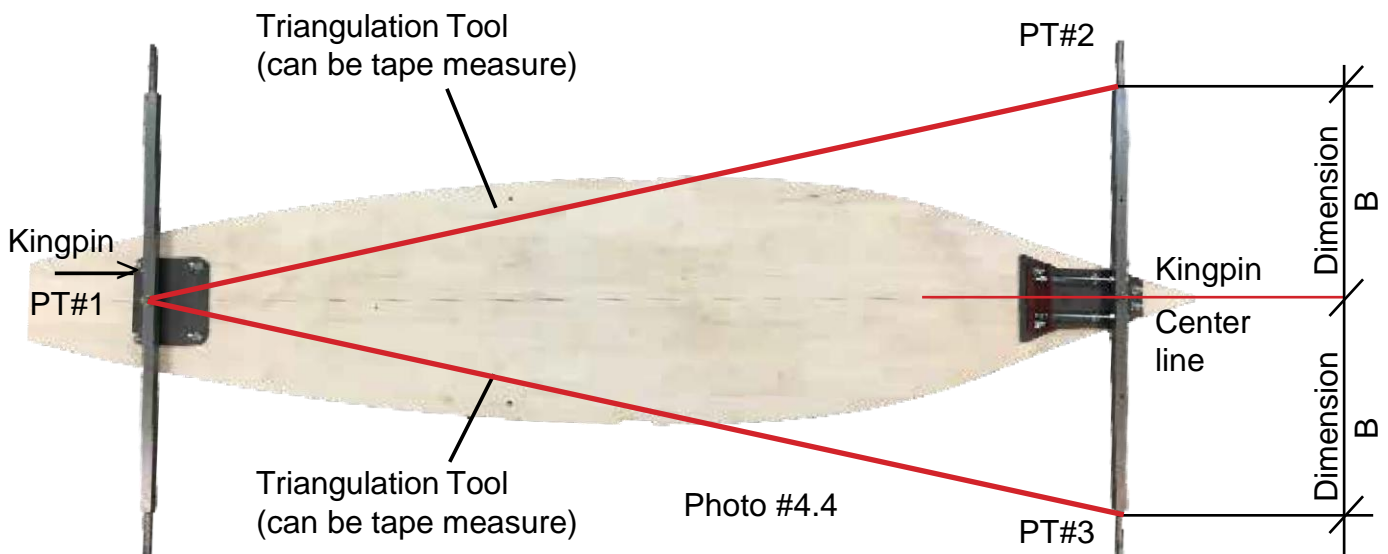

Photo #4.4

Step Five

Steering Kit Base

Steering Kit Base

- Once you've determined where your driver will be positioned in the car you now have to determine where you will place the steering and brake assembly. Where you place the steering assembly is determined by the height of your driver.

5.1

Once the spot for the assembly is determined, center the steering assembly base on the line that was drawn earlier in the plans. A framing square (not provided) can be used to help center the base. See Photo #5.1.

5.2 Mark the four holes in the base with a pencil. Mark the brake plunger hole (square) with a pencil. Mark the steering shaft hole (round) with a pencil. See Photo #5.2.

5.3 Drill a 1 $\frac{1}{8}$ " steering shaft hole (round) into the floorboard $\frac{3}{8}$ " deep (not all the way through the floorboard). See Photo #5.3.

5.4 Drill a 1 $\frac{1}{8}$ " brake plunger hole (square outline, round hole) through the floorboard.

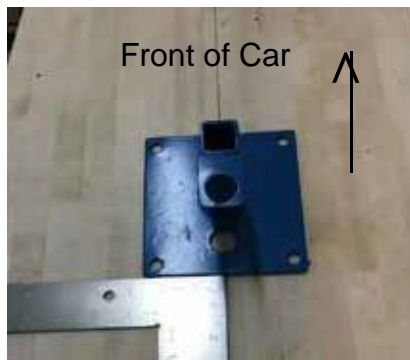

Photo #5.1

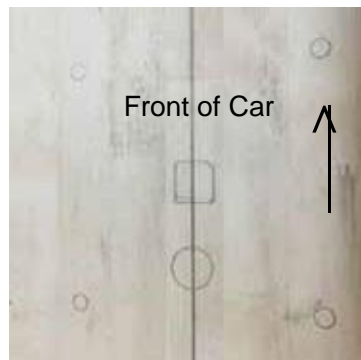

Photo #5.2

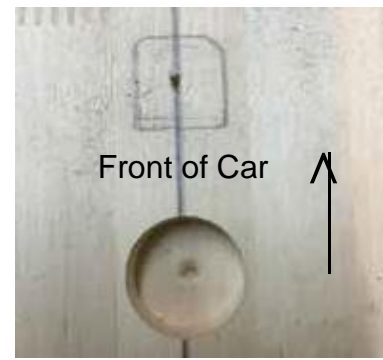

Photo #5.3

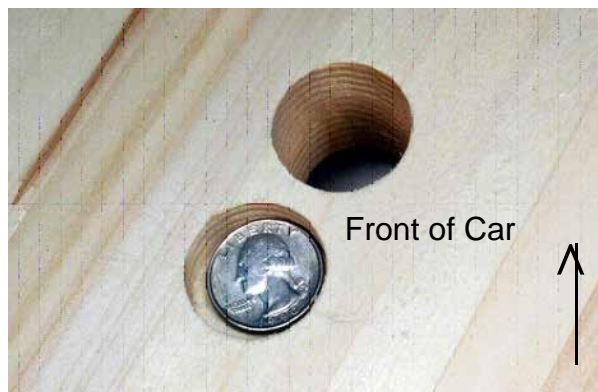

Photo #5.5

Step Five

Continued

- 5.6 Set the steering shaft over the holes and test the plunger to make sure there is proper clearance. See Photo #5.6.
- 5.7 Drill one $\frac{1}{4}$ " hole through the hole in the steering base and through floorboard.
- 5.8 Push one $\frac{1}{4}$ "-20 x 2" Elevator Bolt through the bottom of the floorboard. Add a $\frac{1}{4}$ " washer (SAE Washer Yellow Grade 8) to the bolt. Then add a $\frac{1}{4}$ " lock washer and then a $\frac{1}{4}$ " -20 nut to the bolt and draw flush with the bottom of the floorboard. See Photo #5.8.
- 5.9 Repeat steps 5.7 & 5.8 for the opposite corner. Then repeat the steps for the other two holes. See Photo #5.9.



Photo #5.6



Photo #5.8

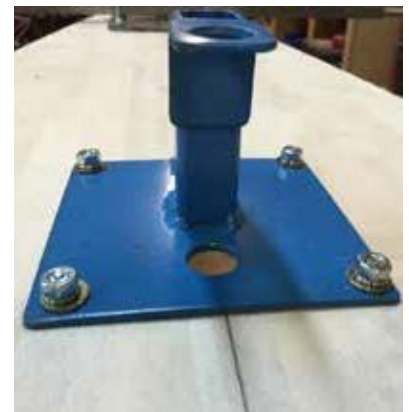

Photo #5.9

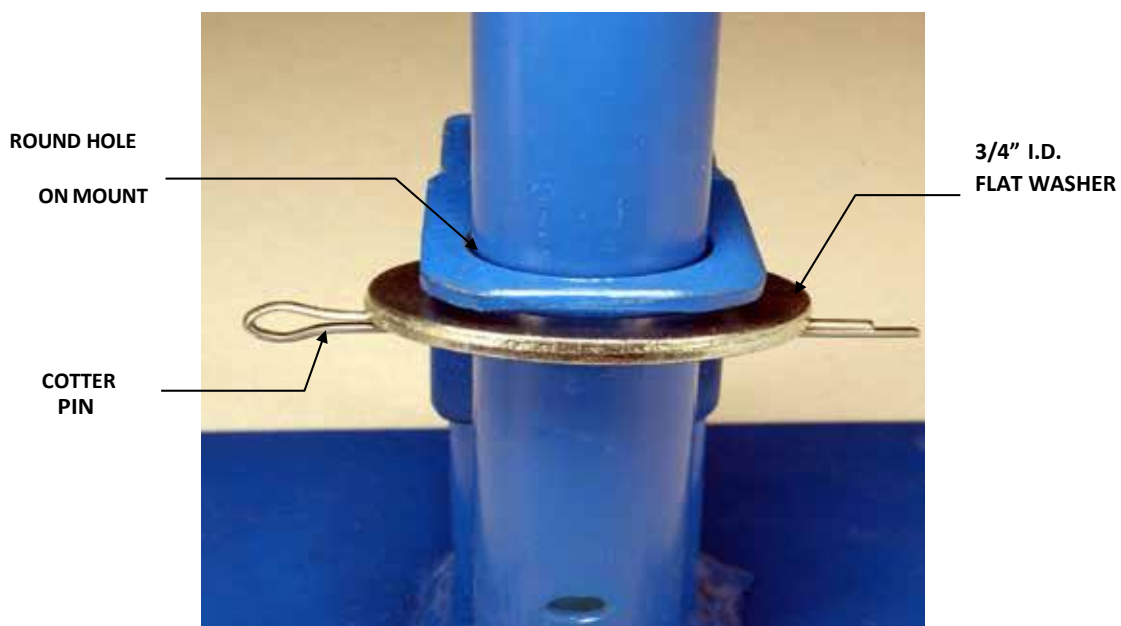

Photo #5.10

Step Six

Brake Pad Installation

Brake Pad Installation

- The brake pad may be installed to the plunger using both a $\frac{1}{4}$ " lock washer and $\frac{1}{4}$ " nut (provided by others) instead of the $\frac{1}{4}$ " lock nut.
- 6.1 Insert one $\frac{1}{4}$ " x $\frac{3}{4}$ " phillips head bolt through each hole of the brake pad. Thick black side should be facing the ground. See Photo # 6.1
 - 6.2 Align bolts in brake pad with holes in flat bottom of the plunger and insert.
 - 6.3 Place a $\frac{1}{4}$ " lock nut (silver in color) on $\frac{1}{4}$ " x $\frac{3}{4}$ " phillips head bolt.
 - 6.4 Tighten assembly. It is recommended that approximately an eighth of the $\frac{1}{4}$ " x $\frac{3}{4}$ " flat head bolt (or three threads) is exposed. The $\frac{1}{4}$ " x $\frac{3}{4}$ " flat head bolt will be recessed in the bottom of the brake pad. See Photo #6.4
 - 6.5 Repeat Steps 6.1 through 6.4 for other three bolt locations.



Photo #6.1

(Brake Pad)

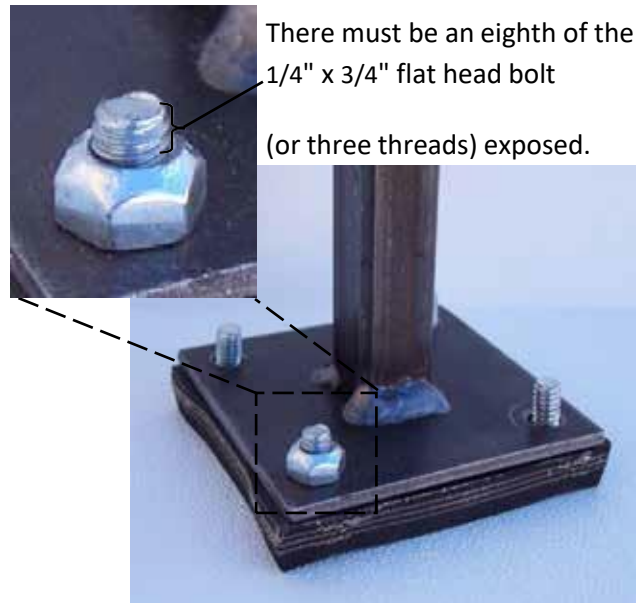

Photo # 6.4

Brake Pad/Plunger Assembly



Step Seven

Brake Plunger

Brake Plunger

- 7.1 Turn floorboard upside down.
- 7.2 Insert brake plunger through the brake plunger hole. See Photo #7.2.
- 7.3 The brake plunger and pad may be countersunk into the floorboard (optional). You can do this using a router and shape it in a square like the brake pad. Outline the brake plunger and pad using a pencil. See Photo #7.3.
- 7.4 Router out the square approximately 1" deep. You'll need to chisel the sides and corners so the brakeplunger and pad will fit. See Photos #7.4 A, B & C.

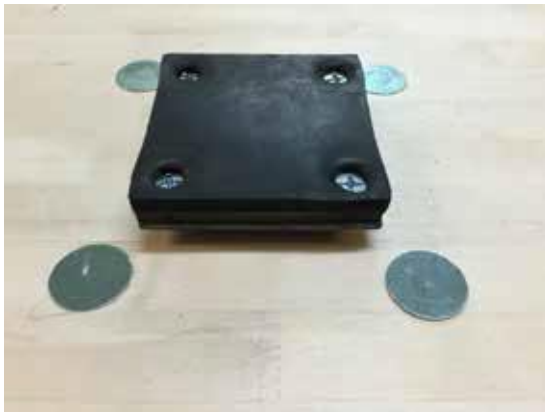

Photo #7.2

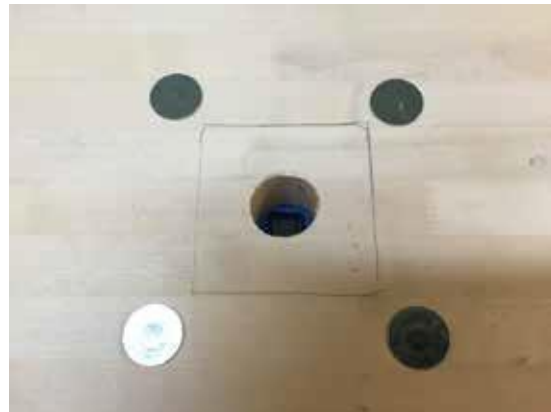

Photo #7.3



Photo #7.4A



Photo #7.4B



Photo #7.4C



Step Eight Steering

AssemblyAxle Eyebolt Sub-Assembly

- 8.1 Install 10-24 nut on 10-24 x 2" eyebolt. Tighten the 10-24 nut to the end of threads on eyebolt.
- 8.2 Insert assembly through driver side of front axle at eyebolt location. See Figure #8.2.
- 8.3 Place a #10 lock washer on the eyebolt.
- 8.4 Install 10-24 nut on eyebolt.
- 8.5 Tighten eyebolt assembly. See Photo #8.5.
- 8.6 Repeat Steps 8.1 through 8.5 for second axle eyebolt assembly.

Cable Adjuster Sub-Assembly

- 8.7 Install 8-32 nut on 8-32 x 1-5/8" eyebolt.
- 8.8 Insert eyebolt through any of the three holes of the inside of the cable adjuster and push through. NOTE: Other types of cable adjusters may be used as long as they are approved by the ISBD RacingCommission.
- 8.9 Place a #8 lock washer on 8-32 x 1-5/8" eyebolt.
- 8.10 Install 8-32 nut on # 8 lock washer. See Photo #8.10.
- 8.11 **Do not completely tighten assembly.** Further adjustments to occur in Step 8.34.
- 8.12 Repeat Steps 8.7 through 8.11 for second cable adjuster assembly.

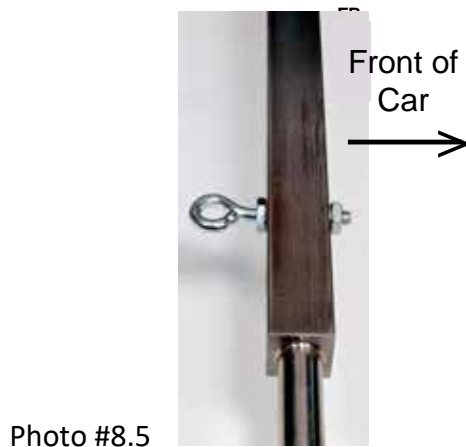
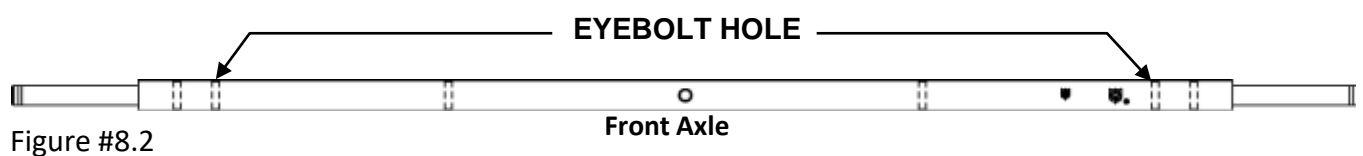

Step Eight

Continued

Cable Pulley Sub-Assembly

- 8.13 Insert one 1/4" x 3" elevator bolt through the floorboard bottom at a steering cable pulley hole location and press through the floorboard. See legend for location of holes.
- 8.14 Place 1/4" x 1 1/4" fender washer(s) on bolt. It is recommended that you use as many washers that will allow you to keep the steering cable level from the axle eyebolt to the pulley. Place pulley on bolt.
- 8.15 Place 1/4" lock washer on top of the cable pulley. Install 1/4" nut on 1/4" bolt. Tighten nut. Repeat steps 8.13-8.14 for second cable pulley location. See Photo #8.15. In this photo example five washers were used to get the pulley level with the eyebolt. How many washers you use in this step will be determined by the number you use on the front kingpin stack.

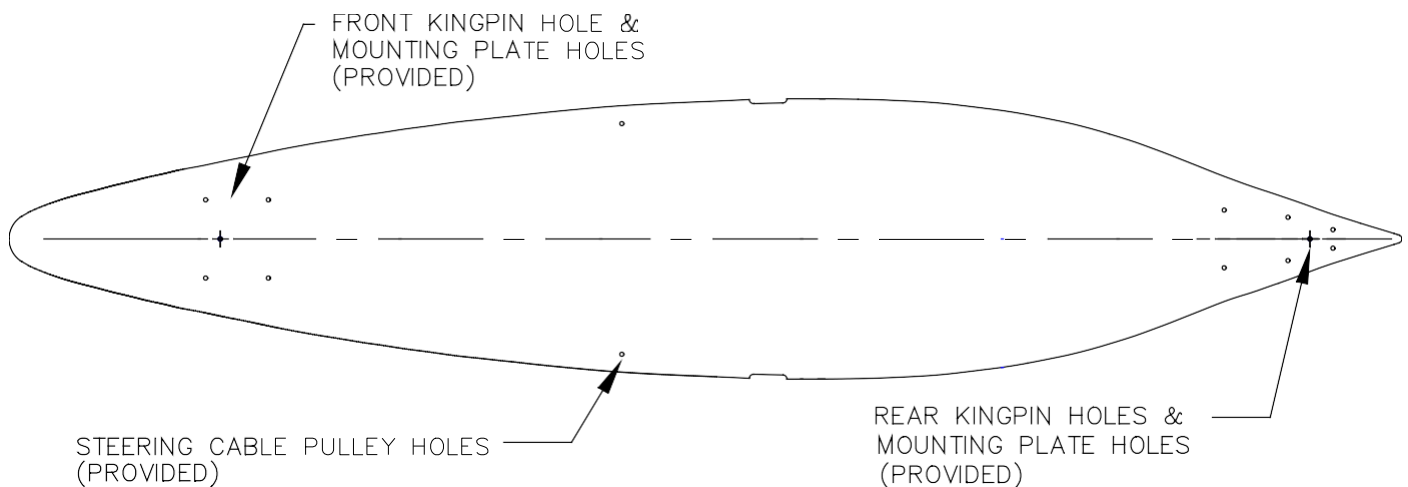

Photo #8.15



Step Eight Continued

Steering Cable Sub-Assembly

- 8.16 Determine the center point of the steering cable by folding the cable in half and squeeze the loop with a pair of pliers.
- 8.17 Insert the two loose ends of the steering cable through the lower hole of the steering wheel shaft located horizontally above the floorboard.
- 8.18 Pull the two loose cable ends through the hole until an eyelet is formed at the center point of steering cable.
- 8.19 Wrap one loose end of cable around shaft 180 degrees and thread through eyelet. See Figure #8.19 – STEP ONE
- 8.20 Wrap other loose cable end in other direction around shaft 180 degrees from first cable, and thread through eyelet.
- 8.21 Pull both cable ends to tighten eyelet to secure cable.
- 8.22 Continue first cable around steering shaft to a minimum of 360 degrees (at least one complete wrap). See Figure # 8.22 – STEP TWO
- 8.23 Center steering wheel and temporarily clamp (or have someone hold) steering wheel from turning.

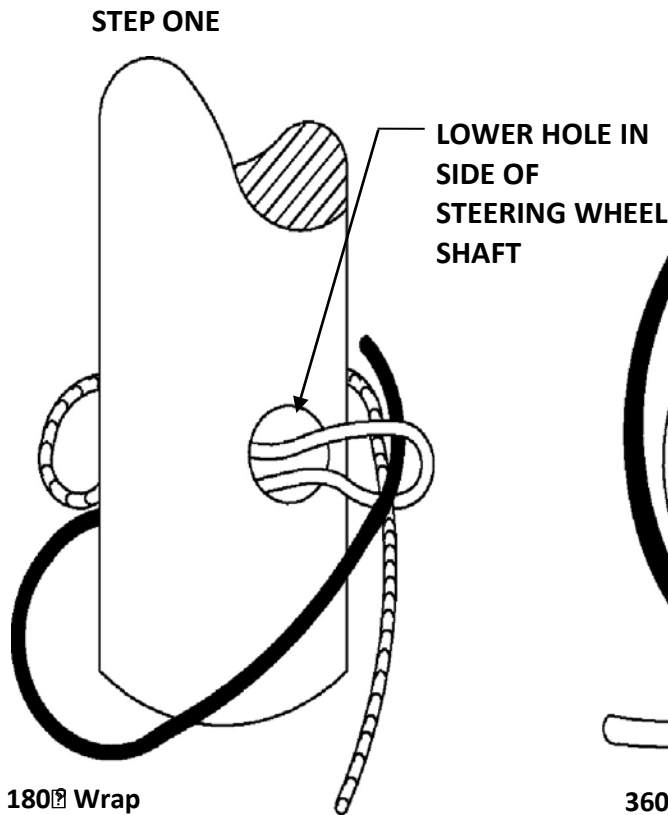

Figure #8.19

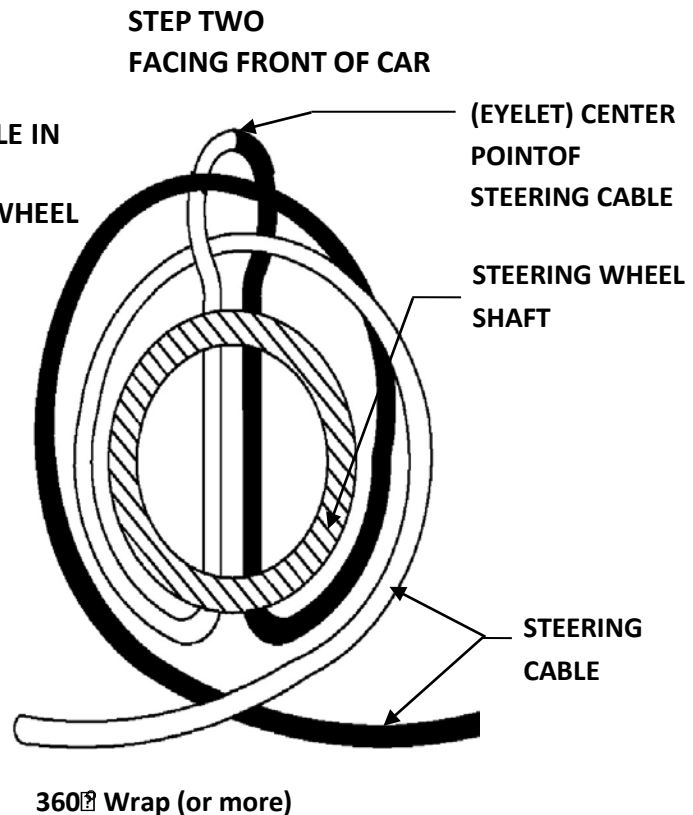

Figure #8.22



Step Eight

Continued

- 8.24 Thread one cable through the outside of one of the two remaining holes in the cable adjuster and into the inside of the cable adjuster.
- 8.25 Thread cable through eyebolt inside cable adjuster.
- 8.26 Thread cable through the remaining hole in the cable adjuster. See Photo #8.26.



Photo #8.26



Photo #8.27

- 8.27 Thread one cable around cable pulley located on floorboard. See Photo #8.27.
- 8.28 Slide two 1/4" cable clamps on cable end.
- 8.29 Thread cable through the front axle eyebolt assembly.
- 8.30 Insert loose end of cable back through both cable clamps.
- 8.31 Pull cables tight and tighten both cable clamps with a 5/64" Allen Wrench. Cable clamps can be placed next to each other or spread apart. See Photo #8.31
- 8.32 Repeat steps 8.24 through 8.31 for the other cable.

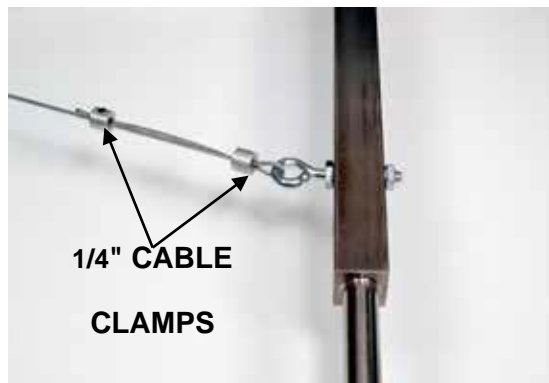

Photo #8.31



Step Eight Continued

- 8.33 Please refer to Photos #8.33(A-C) for cable routing. The front of the car is at the top of each photo.
- 8.34 Adjust steering cables by adjusting 8-32 x 1-5/8" eyebolts in cable adjuster assemblies.
- 8.35 Secure both cable adjusters by tightening both of the 8-32 nuts. Cable adjusters may be located anywhere along the cable. Remove temporary steering wheel clamp from Step 8.23.
- 8.36 Test by pulling the steering with your left hand while seated facing the front of the car. The car should turn to the left.
- 8.37 Excess steering cable may extend past second 1/4" cable clamp and may be removed by cutting. To avoid cable fraying it is recommended that you tape the ends (electrical tape or similar). The tape can cover a maximum of 3/4" of the cable and can be taped to the other cable. See Photo #8.37.
- 8.38 Steering cable adjustment to occur in future Step 10.

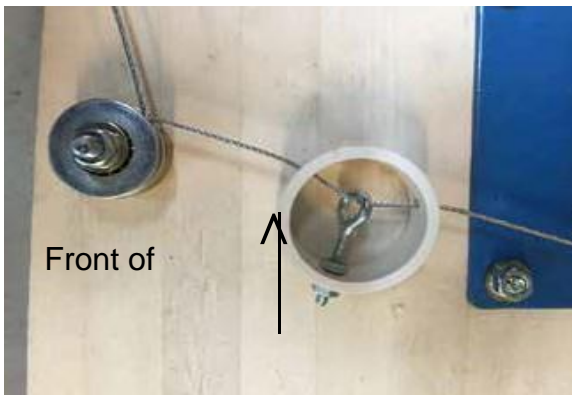

Photo #8.33A

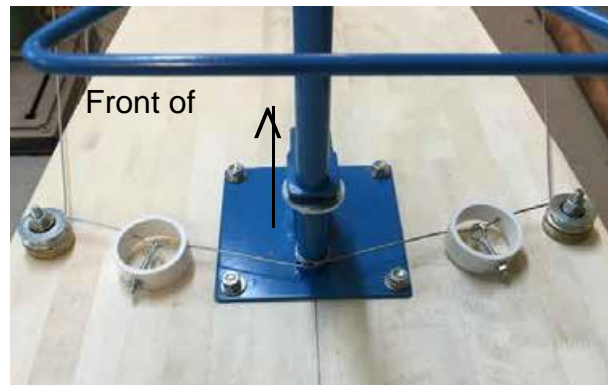

Photo #8.33B

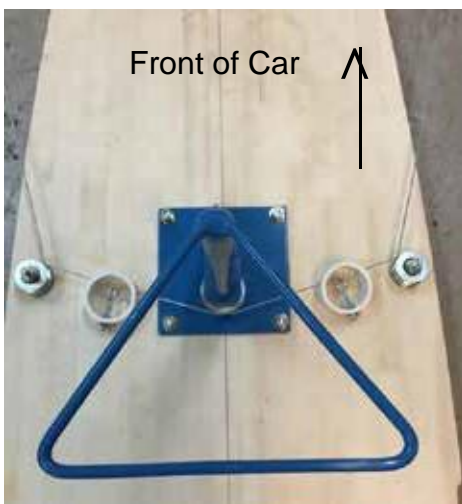

Photo #8.33C



Photo #8.37



Step Nine

Brake Assembly

Brake Pedal Hinge Sub-Assembly

- 9.1 Align the four hinge holes with the brake pedal. Top of the wood brake pedal has rounded corners and the bottom is straight. The fifth hole located at the rounded corner is for brake pedal eyebolt installation.
- 9.2 Insert $\frac{1}{4}$ " x $1\frac{1}{4}$ " flat head bolt through brake pedal and through one of the four hinge holes.
- 9.3 Install $\frac{1}{4}$ " lock washer on $\frac{1}{4}$ " x $1\frac{1}{4}$ " flat head bolt.
- 9.4 Install $\frac{1}{4}$ " nut on $\frac{1}{4}$ " washer. Do not completely tighten. See Photo #9.4.
- 9.5 Repeat Steps 9.2 through 9.4 for other three bolts.
- 9.6 Tighten nuts until bolt heads are flush with face of brake pedal

Brake Pedal Eyebolt Sub-Assembly

- 9.7 Install $\frac{1}{4}$ " nut on $\frac{1}{4}$ " x $2\frac{1}{2}$ " eyebolt. Tighten nut to the end of threads on eyebolt.
- 9.8 Place $\frac{1}{4}$ " x $1\frac{1}{4}$ " fender washer on the eyebolt.
- 9.9 Insert eyebolt assembly through the hole in the wood brake pedal on side opposite hinge.
- 9.10 Place $\frac{1}{4}$ " x $1\frac{1}{4}$ " fender washer on the brake pedal eyebolt assembly.
- 9.11 Install $\frac{1}{4}$ " lock washer on $\frac{1}{4}$ " x $1\frac{1}{4}$ " fender washer.



Photo #9.4

(Partial image shown for clarity)



Photo #9.12

(Eyelet to back of car)

(Partial image shown for clarity)



Step Nine

Continued

Brake Pedal Hinge Sub-Assembly at Floorboard

- It's important to have your shell built and in place so you can determine the location of the brake pedal hinge. There is a lot of forward movement with the brake pedal so you need to make sure you have full travel when operating the brake. Determine where you want to place the brake pedal hinge. This is based on the driver location.
- 9.13 Place the brake pedal hinge on the floorboard and, with a pencil, mark the location of the two outer hole locations. Drill two $\frac{1}{4}$ " holes (outside holes, middle hole is not used) through the floorboard.
- 9.14 Align the two outer holes of the brake pedal hinge with holes in floorboard.
- 9.15 Insert one $\frac{1}{4}$ " x $2\frac{1}{4}$ " elevator bolt through the floorboard bottom at a brake pedal hole location and press through the floorboard and brake pedal hinge hole. Place brake pedal assembly over bolt.
- 9.16 Place $\frac{1}{4}$ " lock washer on $\frac{1}{4}$ " x $2\frac{1}{4}$ " elevator bolt.
- 9.17 Install $\frac{1}{4}$ " nut on $\frac{1}{4}$ " lock washer. Do not completely tighten.
- 9.18 Repeat Steps 9.15 through 9.17 for second bolt.
- 9.19 Tighten both nuts until bolts are drawn in flush with bottom of floorboard. See Photo #9.19

Cable Pulley Sub-Assembly at Brake/Steering Mount

- 9.20 Insert $\frac{1}{4}$ " x 1" machine bolt through cable pulley.
- 9.21 Place $\frac{1}{4}$ " flat washer on $\frac{1}{4}$ " x 1" machine bolt.
- 9.22 Insert $\frac{1}{4}$ " x 1" machine bolt with cable pulley and flat washer through hole in the left side of the vertical plate of the brake/steering mount.
- 9.23 Place $\frac{1}{4}$ " lock washer on the machine bolt assembly.
- 9.24 Install $\frac{1}{4}$ " nut on $\frac{1}{4}$ " lock washer.
- 9.25 Tighten assembly. Cable pulley shall spin freely. See Photo # 9.25.

Photo #9.19



Photo #9.25

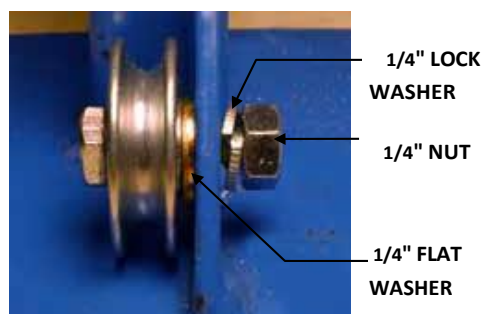

Step Nine

Continued

Plunger Sub-Assembly

- 9.26 Install ¼" nut on ¼" x 2½" eyebolt. Tighten nut to end of threads on eyebolt.
- 9.27 Insert square tube end of brake plunger assembly through bottom of floorboard at large round hole of brake/steering mount and push through top of brake/steering mount. Make sure holes are aligned front to back.
- 9.28 Place brake spring on brake plunger.
- 9.29 Compress brake spring coil and insert eyebolt assembly through hole of plunger (eyebolt faces front of car).
- 9.30 Place ¼" lock washer on the eyebolt assembly.
- 9.31 Install ¼" nut on eyebolt.
- 9.32 Tighten eyebolt assembly. See Photo 9.32.



Photo #9.32

Brake Cable Assembly

- 9.34 Place two cable clamps on one end of brake cable and thread it through the eyebolt located on the brake plunger (can be single or double looped). See Photo #9.34
- 9.35 Thread the brake cable through both cable clamps. Tighten each clamp.
- 9.36 Thread the brake cable down beside the brake plunger and under the pulley. Tighten the cable pulley (make sure the brake cable is underneath the pulley).
- 9.37 Thread the brake cable through two cable clamps. Thread the brake cable through the eye bolt on the brake pedal (can be single or double looped). See Photo #9.37.
- 9.38 Tighten cable and thread through both cable clamps. Tighten clamps. Cut off excess cable. Ends can be taped together. See Photo #9.38



Step Nine

Continued



Photo #9.34



Photo #9.37

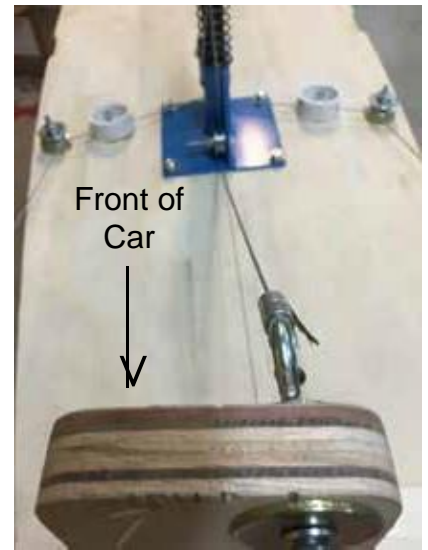

Photo #9.38

Foot brace installation

- A functional foot brace must be installed.
- Builder may install the foot brace supplied with the kit or make their own of steel, wood, or aluminum.
- Builder may also install their own 3/4" height x 3/4" width x 3" length (minimum measurements) foot brace in the car. The 3" length must be parallel to the axle.
- You may NOT install the foot brace under the wood brake pedal hinge.
- The brake pedal is NOT considered a foot brace.

9.39 Position the foot brace in the desired position and drill two 1/4" holes through the foot brace and the floorboard.

9.40 Insert two 1/4" x 3" elevator bolts through the floorboard bottom at a foot brace hole location and press through the floorboard.

9.41 Install 1/4" x 1 1/4" fender washer on elevator bolt along with a nut and draw flush with floorboard. Take off washer and nut.

9.42 Place foot brace on the elevator bolt.

9.43 Place a 1/4" x 1 1/4" fender washer on the elevator bolt on top of the foot brace.

9.44 Install 1/4" nut on 1/4" x 1 1/4" fender washer. See Photo #9.44.

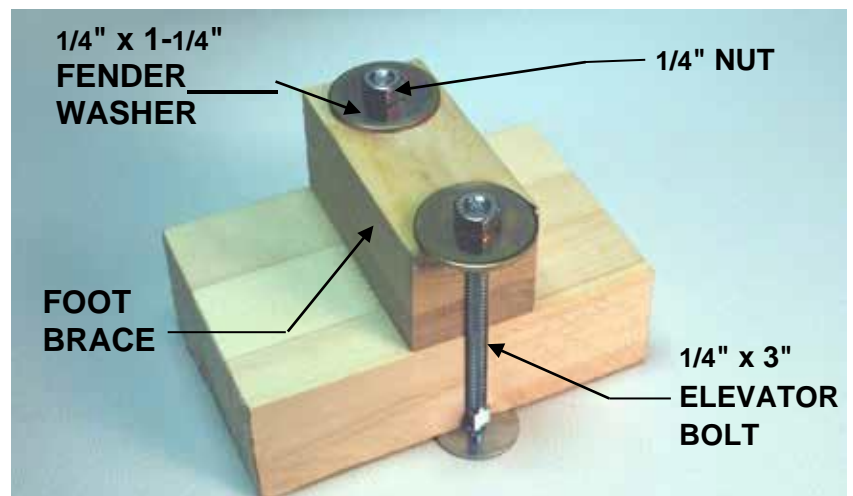

Photo #9.44



Step Ten

Front Axle Alignment

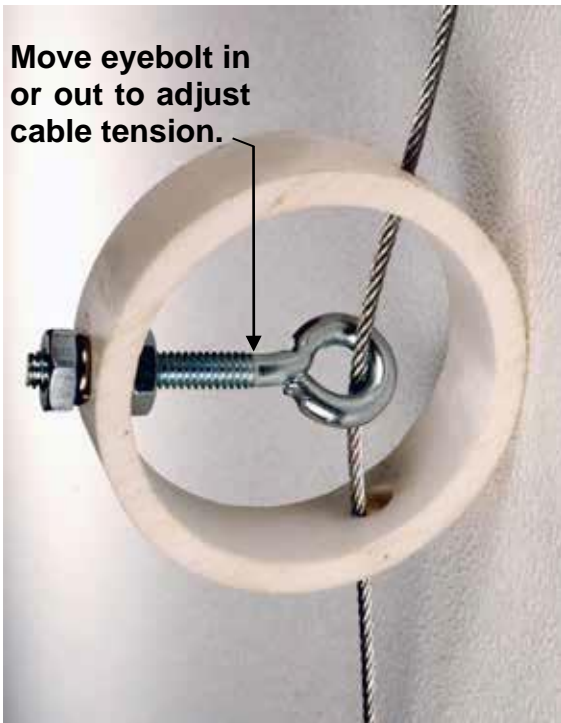

Photo #10.2(a)

(Cable Adjuster Assembly)

Front Axle Alignment

- 10.1 The front axle will need to be aligned to ensure that the steering wheel is properly centered to allow the car to properly track in a straight line. Contact your local Derby Director for other available methods and assistance.
- 10.2 Center the steering wheel. Measure from the back edge of the rear axle to the back edge of the front axle on both sides. Tighten or loosen the steering cables at the cable adjuster eyebolt until Dimension C is exactly the same on both sides. See Photo #10.2(a) and Photo #10.2(b)
- 10.3 Tighten nuts on both sides of the cable adjuster.
- 10.4 Check the measurement to ensure that it is equal. The steering cable should be tight; however, not so tight that it bows the front axle.
- 10.5 Make sure that the axle turns in the same direction as the steering wheel.
- 10.6 Tighten all parts of the steering assembly as shown in Step Eight.
- 10.7 Steering cable excess length may be cut off past the cable clamps. To avoid cable fraying it is recommended that solder be applied a $\frac{1}{4}$ " +/- on each side of the proposed cut **prior to cutting.**

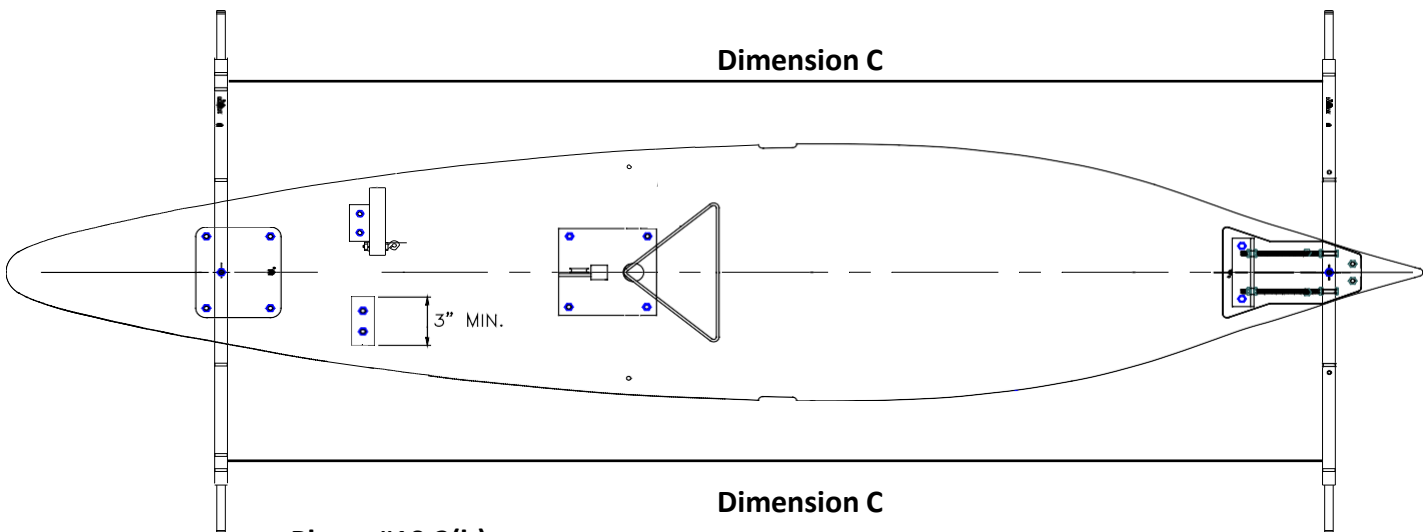

Photo #10.2(b)

Step Eleven

Airfoils

Front Airfoil (shorter)

- 11.1 Align front airfoil with outside axle (square stock). Make sure your airfoil does not extend past the square stock. If it does your wheels will rub up against the airfoil.
- 11.2 With a pencil mark the spot on the airfoil where the nut and eye bolt come through the axle. See Photo #11.2.
- 11.3 Drill a ½" diameter hole ½" deep that will act as a pocket for the nut and eyebolt. See Photo #11.3.
- 11.4 Clamp airfoil to axle. See Photo #11.4.
- 11.5 Place a 2" drywall screw through a ¼" finish washer.
- 11.6 Insert 2" drywall screw with ¼" finish washer through rear surface holes of axle square stock. Tighten assembly. Recommend hand drive only. See Photo #11.6.
- 11.7 Repeat steps for other front airfoil.



Photo #11.2



Photo #11.3



Photo #11.4



Photo #11.6

Rear Airfoil (longer)

- 11.8 Align rear airfoil with outside axle (square stock). Make sure your airfoil does not extend past the square stock. If it does your wheels will rub up against the airfoil. Clamp airfoil to axle. See Photo #11.8.
- 11.9 Place a 2" drywall screw through a ¼" finish washer. Insert 2" drywall screw with ¼" finish washer through rear surface holes of axle square stock. Tighten assembly. Recommend hand drive only. See Photo #11.6. Repeat steps for other rear airfoil.



Photo #11.8

NOTE: Airfoils can only be painted.

Step Twelve

Axle/Steering Cable

CutoutsAxle Cutouts

- 12.1 To determine where your cutouts for the axles will be you need to align the shell with the floorboard. Place shell on top of floorboard with all running gear built. See Photo #12.1.
- 12.2 Using a square tool, line the front of the shell with the front of the floorboard. Leave approximately a $\frac{1}{8}$ " gap between the floorboard and the square, which is flush with the shell. See Photo #12.2.
- 12.3 Using a pencil mark the top of each airfoil. See Photo #12.3



Photo #12.1



Photo #12.2



Photo #12.3

- 12.4 Remove all four airfoils. See Photo #12.4A. NOTE: MAKE SURE YOU MARK WHERE YOU REMOVED EACH AIRFOIL. See Photo #12.4B.
- 12.5 Using a saw of your choice cut each airfoil along each line. See Photo #12.5.
- 12.6 Place shell back on floorboard/running gear. Make sure you use the square and leave approximately a $\frac{1}{8}$ " gap between the floorboard and the square, which is flush with the shell. NOTE: You may want to place two wood blocks under the shell to lift it off the floorboard so it's easier to turn the steering wheel in the next step. See Photo #12.6.
- 12.7 Turn steering wheel all the way to the right (do not move shell).



Photo #12.4A



Photo #12.4B



Photo #12.5



Photo #12.6



Step Twelve

Continued

12.8 Using the square and a pencil, mark the front edge of the left side front axle. See Photos #12.8A-B.

12.9 Using the square and a pencil, mark the back edge of the right side front axle. See Photos #12.9.



Photo #12.8A



Photo #12.8B



Photo #12.9

12.10 Turn steering wheel all the way to the left (do not move shell).

12.11 Using the square and a pencil, mark the rear edge of the left side front axle. See Photo #12.11.

12.12 Using the square and a pencil, mark the front edge of the right side front axle. See Photo #12.12.

12.13 Using the square and a pencil, mark the front and back edges of both sides of the rear axle. See Photo#12.13.

12.14 Measure from the bottom of the floorboard to the top of the axle. See Photo #12.14.

12.15 Now take that measurement and measure from the bottom of the shell up. Mark a line perpendicular each axle line. See Photo #12.15.

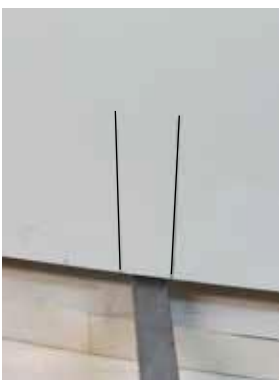

Photo #12.11

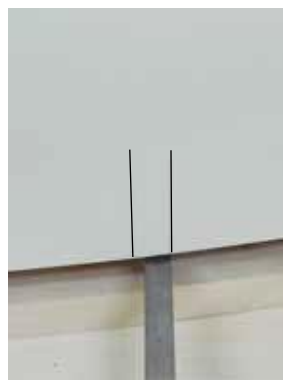

Photo #12.12



Photo #12.13



Photo #12.14



Step Twelve Continued

12.16 Repeat steps 12.14 - 12.15 for the other three axle locations.

12.17 Using the square and a pencil, mark location of each steering cable. See Photo #12.17.

12.18 Measure from the bottom of the floorboard to the top of the steering cable. See Photo #12.18.

12.19 Now take that measurement and measure from the bottom of the shell up. Mark a line. See Photo#12.19.

12.20 Measure $1\frac{1}{2}$ " on each side of the steering cable line and mark. See Photo #12.20.



Photo #12.15



Photo #12.17



Photo #12.18



Photo #12.19

12.21 From the line that you marked in step 12.19 draw a line to each $1\frac{1}{2}$ " mark on each side of the cableline mark. See Photos #12.21A-B.

12.22 Remove shell piece that will be the axle cutout. We suggest using a hacksaw blade designed for cutting tile. See Photo #12.22.



Photo #12.20



Photo #12.21A

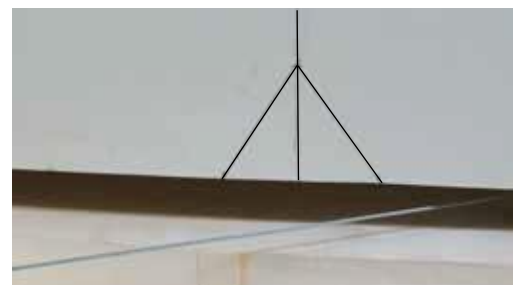

Photo #12.21B



Step Twelve Continued

12.23 Repeat step 12.22 for the other three axle locations.

12.24 Remove shell piece that will be the steering cable cutout. We suggest using a hacksaw blade designed for cutting tile. See Photo #12.24.

12.25 Repeat step 12.24 for the other steering cable cutout. NOTE: You can save the cutout pieces to install on the floorboard under the axle to fill the void. THIS IS OPTIONAL.

12.26 You can use sandpaper to smooth the edges around the cutouts. See Photo #12.26.

12.27 Reinstall airfoils. Trim as needed.



Photo #12.22



Photo #12.24



Photo #12.26



Step Thirteen

Shell Attachment

Shell Attachment

- The body dimension of $36\frac{1}{2}$ " must be maintained. The measurement is taken over the hinge recessed area where the shell meets the hatch opening. The measurement is taken from the bottom of the shell on the left over the top of the shell to the bottom of the shell on the right side. See Photos #13.1A-C



Photo #13.1A

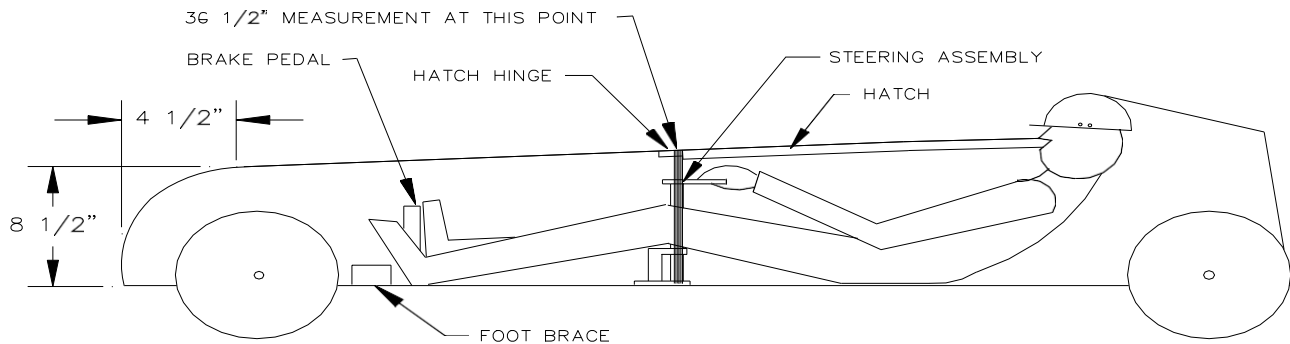

Photo #13.1B



Photo #13.1C

- If your car does not measure $36\frac{1}{2}$ " the shell must be raised on the floorboard to meet the required measurement. The shell must be installed flush to the nose of the floorboard (No gap). **The height of the nose shall be $8\frac{1}{2}$ " high at $4\frac{1}{2}$ " back from the front of the car - measurement is taken on the outside of the car.** See figure 1.0). This verifies an unaltered shell. Notch your nose gauge for the screw in the nose of the shell. Do not include the screw and washer as part of the nose height measurement. See Photo



#13.2.



Photo #13.2

FIG 0



Step Thirteen

Shell Attachment continued

- The shell may be raised or raked a maximum of $\frac{1}{2}$ " to allow for a larger driver.
- The shell must be secured with a minimum of 48 screws. You may have more. These screws must be $1\frac{1}{4}$ " drywall screws with finish washers.
- If you use a piece of the shell under your axle or cable openings you must use a drywall screw and finish washer drilled through it, to hold it in place. It may be one of the 48 screws.
- One screw with a finish washer must be in the nose of the car. NOTE: It is recommended that you place the screws $\frac{3}{4}$ " from the bottom of the shell. This will place the screw in the middle of the floorboard.
- It is also recommended that you pre-drill $\frac{9}{64}$ " holes through the shell prior to installing the drywall screws. This will make it easier to install the drywall screws.

Step Fourteen

Weight

- Combined weight of the car and driver shall not exceed 255 pounds with Z-Glas wheels.
- If using adjustable weight(s) you must drill your own weight holes ($\frac{5}{16}$ ").
- The maximum length for weight plates shall not exceed 12" long.
- The weight plates must be removable without removing any running gear, steering or brake components.
- No more than (2) $\frac{5}{16}$ " bolts per plate are permitted to secure weight.
- A $\frac{1}{8}$ " gap must be maintained between weights. Weight may not touch sides of the car or any assemblies.
- Lead weight must be painted, and the weight of all weight material pieces must be clearly marked.
- T Nuts are permitted for all weights, if installed from the bottom of the floorboard.
- Weight will only be permitted in the new weight zone for the 2020 season.
- **The weight zone is between axle mounting plates and behind the rear mounting plates. $\frac{1}{8}$ " clearance must be maintained.**



Adjustable Weight

- Each car must have at least one anchoring bolt or threaded rod with a wing nut safely installed in the car body for quick adjustment of weight.
- The recommended amount of adjustment weight is 10 pounds (suggested increments of (3) two pounds, (3) one-pound and (2) eight-ounces) mounted securely by a 5/16" diameter bolt, held by a wing nut and installed within reach of the cockpit area for easy adjustment.
- If bar bell style weights are used, the large center hole must be filled with a dowel rod until the weights fit securely on the 5/16" weight bolt. Shifting or any type of movement in the weights is prohibited.
- No adjustable weight with the height more than 1½" will be allowed between the legs of the driver and steering shaft.
- Cut any excess length of the adjustable weight bolt behind the driver's head and pad for safety.
- Stack adjustable weights from largest (footprint) on bottom to smallest on top.
- Any weight added behind the rear axle mounting plate must be on a 5/16 bolt. The bolt can be no longer than 6 inches from the top of the floorboard.

Prohibited Weight:

- Pouring of melted metal into the car floorboard or body is prohibited. Within the interior of the car all weight must be removable.
- Welding of weights together will not be permitted.
- Wing nuts are not permitted on weights under driver's body.
- Weight is not permitted in a seating or heel area which has been recessed.
- Chained weight is not allowed, that is weights which overlap to create more than 12" support to the floorboard.
- Suspended weight is illegal. No cushion (sponge, rubber, springs, etc.) or other material may be used between the weights or the weight and the floorboard.
- Threaded inserts in the floorboard are not allowed to secure weights.
- Weight is not permitted to be cantilevered or bowed (must be flat).
- Weights must have circular holes to secure them to the floorboard. Slotted weights are not permitted. All weights must stay stationary while racing. If you need to use slotted weights, the unused portion of the weight slots must be filled with standard weight materials to maintain a bolt hole opening only for the weight bolt. The weight bolt washer and nut must hold the assembly together. The photo below shows an example of filling the slot with a wooden dowel rod. The material must be underneath the washer to be held in place.

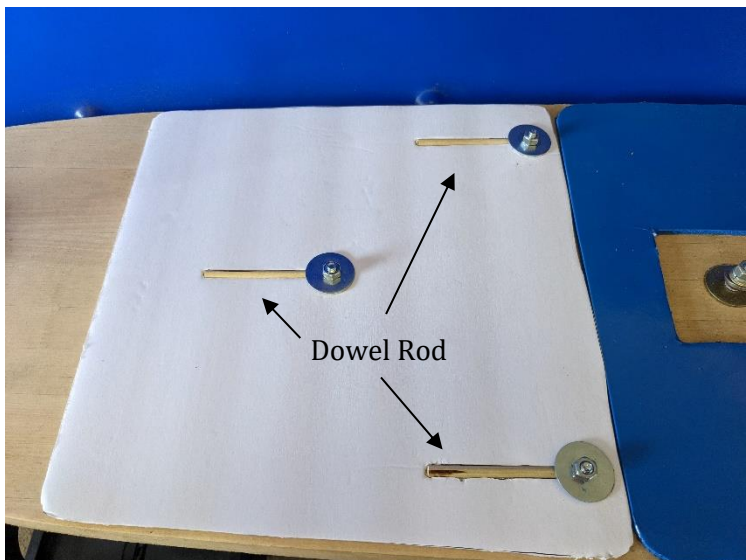

Step Fifteen

Lettering and Decorations

Lettering and Decorations

1. ISBD National Sponsor Decals, Size and Placement
 - a. Decals will be placed in the area located 2" above the bottom of the floorboard, not covering any screws attachment and continue up 10" toward the top of the race car. This area will begin at the front of the hatch and continue forward for 24". See Figure 15.
2. Local sponsor and city decals
 - a. The car sponsor, local sponsor, race city, and driver's name can be placed on the left and right side of the racer. This area will be 30" in length and placed below the hatch opening. The car sponsor, local sponsor, race city, and driver's name are not mandatory decals; however, if you wish to have them on the car and would not like them covered in any way by mandatory decals, the cockpit area is the guaranteed free space. Race city name is mandatory at the All-American race on championship cars. See Figure 15.
3. AASBD Logo

The AASBD decal must be placed on both sides of the car in the AASBD sponsor decal section. See figure 15.
4. All decals must be on all cars during any local, rally and All-American race. All decals must remain in their original condition. Alterations or coatings are not permitted.
5. Shell may be painted on the outside only. Overspray on inside of shell is not permitted.
6. The entire exterior surface of the shell may be finished with solid sheets or decorative cutouts of self-adhesive vinyl material applied in a single layer.

Exceptions:

 - 1) If sheet adhesive vinyl material is used, all International Soap Box Derby, Inc. sponsor decals must be placed over the vinyl material.
 - 2) No vinyl is permitted on the inside of car.
 - 3) No signage, lettering and/or decoration may cover any screw attachments (washers and screws).

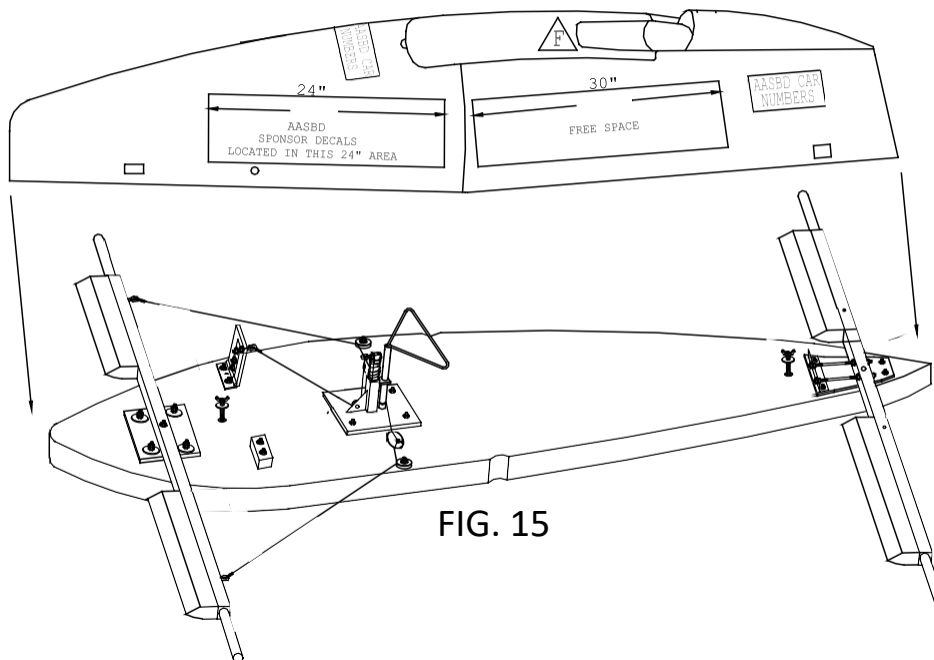

FIG. 15

Step Sixteen

Wheel Installation

Wheel Installation

- 16.1 Place a Z-Glas® wheel (purchased separately) on an axle spindle.
- 16.2 Place a wheel washer on the axle spindle with the Z-Glas® wheel.
- 16.3 Install wheel pin from front of axle through horizontal hole in axle spindle. See Photo #16.3 Roundportion of wheel pin shall face the front of the car.
- 16.4 Repeat Steps 16.1 through 16.3 for the other three wheels.
- 16.5 May use 0 to 2 washers per spindle.

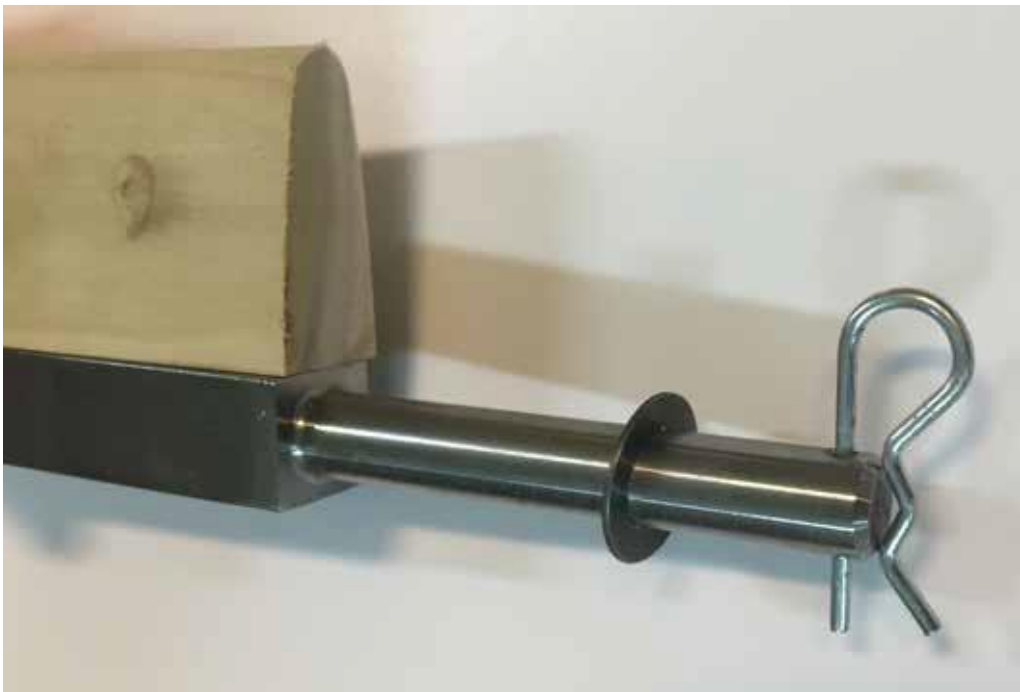

Photo #16.3



Step Seventeen

Assembly Checklist

Carefully review the checklist below to ensure that you have completed the assembly of your car. The Installation Steps are provided so that you may easily reference the work completed at each item identified.

_____ Pre-Build	Page 9
_____ Step One - Shell Construction - Prep For Hatch	Page 10
_____ Step One - Shell Construction - Hatch Attachment	Page 12
_____ Step One - Shell Construction - Attach Hinge To Hatch	Page 15
_____ Step One - Shell Construction - Attach Hinge To Shell	Page 16
_____ Step One - Shell Construction - Headrest	Page 17
_____ Step One - Shell Construction - Helmet Bracket	Page 19
_____ Step One - Shell Construction - Hatch Foam	Page 21
_____ Step One - Shell Construction - Face Protection/Headrest	Page 22
_____ Step Two - Front Running Gear	Page 25
_____ Step Three - Rear Running Gear	Page 28
_____ Step Four - Triangulation	Page 32
_____ Step Five - Steering Kit Base	Page 33
_____ Step Six - Brake Pad Installation	Page 35
_____ Step Seven - Brake Plunger	Page 36
_____ Step Eight - Steering Assembly	Page 37
_____ Step Nine - Brake Assembly	Page 42
_____ Step Ten - Front Axle Alignment	Page 46
_____ Step Eleven - Airfoils	Page 47
_____ Step Twelve - Axle/Steering Cable Cutouts	Page 48
_____ Step Thirteen - Shell Attachment	Page 52
_____ Step Fourteen - Weights	Page 54
_____ Step Fifteen - Lettering & Decorations	Page 55
_____ Step Sixteen - Wheel Installation	Page 56

Congratulations on completing your car. You are now ready to race!

